







www.goldiranac.ir
0 2 1 - 2 3 0 0 8

OWNER'S & INSTALLATION MANUAL

Air-cooled Scroll Chiller

Thank you very much for purchasing our air conditioner,
Before using your air conditioner , please read this manual carefully and keep it for future reference.

ACCESSORIES

Unit	Installation & Operation Manual	Temperature testing components of total water outlet	Wire control assembly	Flow control WFS-1001-H	Installation manual of wire controller
Qty.	1	1	1	1	1
Shape					
Purpose	—	Use for installation (only need for setting the main module)			

MAIN PARTS OF THE UNIT

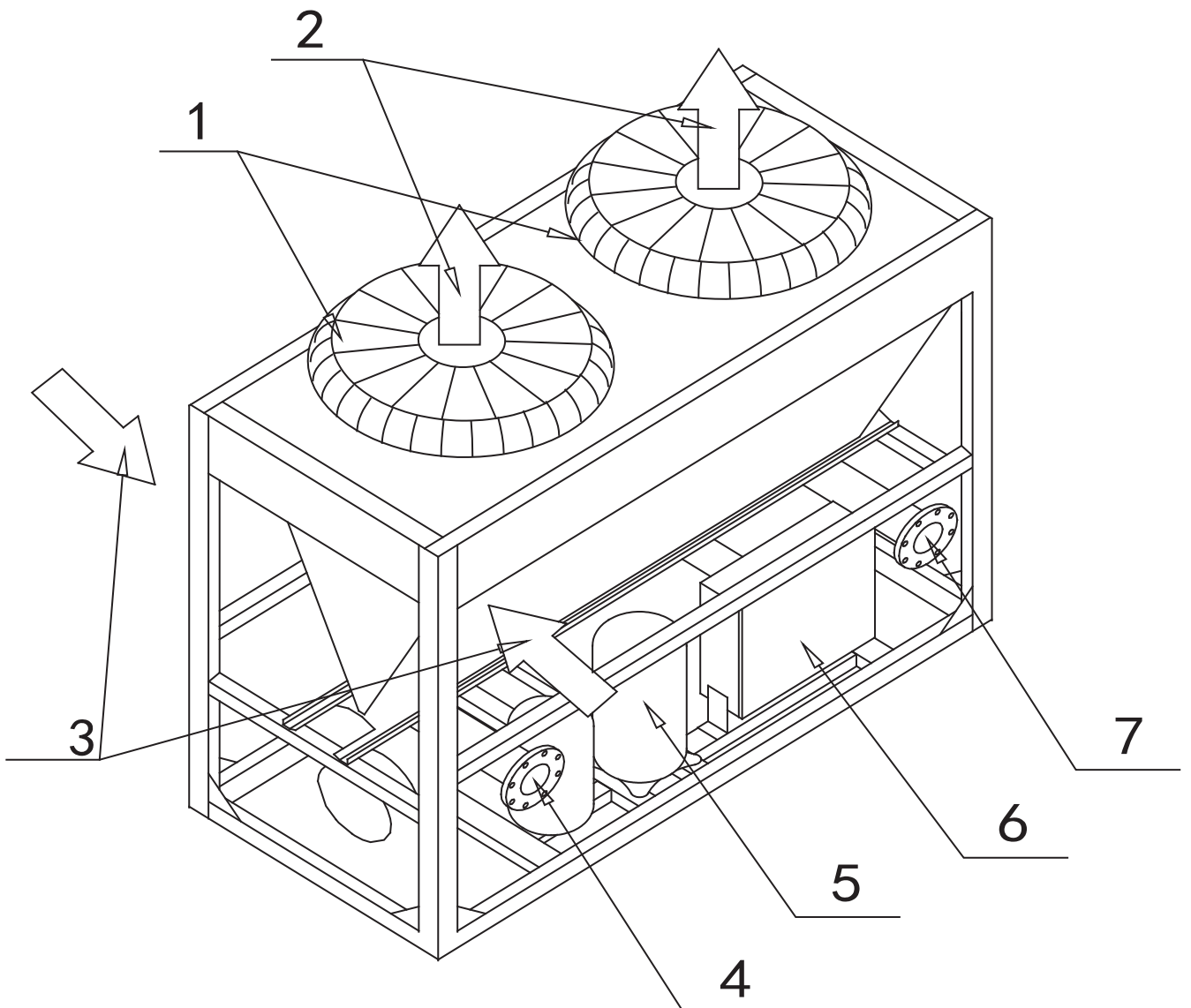

NO.	1	2	3	4	5	6	7
NAME	Top cover	Air outlet	Air inlet	Water outlet	Compressor	Electric control box	Water inlet

OPERATION & PERFORMANCE

Performance characteristics of the unit

The air-cooled heat pump scroll unit is composed of one or more modules. Each module has its own independent electric control unit, and the electric control units of modules conduct information exchange through communication network. The air-cooled heat pump scroll unit is characteristics of compact structure and easy transportation and lifting, and in the meanwhile, it also saves facilities, including cooling tower, cooling pump, and so on, for the user, and reduces installation cost.

The units provide central air handling devices or terminal equipment with chilled water or hot water. The unit is a completely independent entirety type one, which is designed to be installed outdoors (on the ground or the roof). Each unit includes such main parts as high-efficient and low-noise scroll compressor, air-cooled condenser, shell and tube (or plate) evaporator, micro-computer control center, and so on. These parts are installed on steel structure base, so they are sound and durable.

The unit applies Chinese micro-computer control system, which can automatically conduct energy control according to the magnitude of load, to achieve optimal matching and thus actually realizing optimal energy-saving operation. The product is scrollized unit, and parallel connection of 16 modules can be realized at most, so the user can adopt module combination according his own demands. The product can be widely applied in air-conditioning engineering of various newly-built and rebuilt industrial and civil buildings, such as restaurant, hotel, apartment, office building, hospital, industrial plant, and so on. The air-cooled heat pump scroll unit is the best choice for the place which has high requirement in noise and ambient environment and which is short of water.

Use conditions of the unit

a. The standard voltage of power supply is 380-400V 3N~50Hz, the minimum allowable voltage is 342V, and the maximum voltage is 440V.

b. To maintain better performance, please operate the unit under the following outdoor temperature:

Operating range under cooling mode	Operating range under heating mode
10°C~46°C	-10°C~21°C

c. The unit is of outlet water temperature control mode

Outlet water temperature control—cooling: minimum temperature 5°C, maximum temperature 17°C; heating: minimum temperature 45°C, maximum temperature 50°C.

If low-temperature water outlet unit is required, it should specially be customized.



If the user requires the unit to operate under the outlet water temperature is lower than the minimum setting value mentioned above, be sure to make the requirement to the dealer or our maintenance center, and necessary protective measures should be taken before the unit is used.

CONTENTS	PAGE
PRECAUTIONS.....	1
TRANSPORTATION.....	2
INSTALLATION OF THE UNIT.....	3
WATER SYSTEM INSTALLATION	6
ELECTRIC WIRING.....	17
TRIAL RUN.....	22
USE.....	23
MAINTENANCE AND UPKEEP.....	26
APPLICABLE MODELS AND MAIN PARAMETERS.....	32
ATTACHED PICTURE	33

1. PRECAUTIONS

To prevent injury to the user or other people and property damage, the following instructions must be followed. Incorrect operation due to ignoring of instructions may cause harm or damage.

The safety precautions listed here are divided into two categories. In either case, important safety information is listed which must be read carefully.



WARNING

Failure to observe a warning may result in death.



CAUTION

Failure to observe a caution may result injury or damage to the equipment.



WARNING

- **Ask your dealer for installation of the air conditioner.**
Incomplete installation performed by yourself may result in a water leakage, electric shock, and fire.
- **Ask your dealer for improvement, repair, and maintenance.**
Incomplete improvement, repair, and maintenance may result in a water leakage, electric shock, and fire.
- **In order to avoid electric shock, fire or injury, or if you detect any abnormality such as smell of fire, turn off the power supply and call your dealer for instructions.**
- **Never replace a fuse with that of wrong rated current or other wires when a fuse blows out.**
Use of wire or copper wire may cause the unit to break down or cause a fire.
- **Do not insert fingers, rods or other objects into the air inlet or outlet.**
When the fan is rotating at high speed, it will cause injury.
- **Never use a flammable spray such as hair spray, lacquer or paint near the unit.**
It may cause a fire.

- **Never inspect or service the unit by yourself.**
Ask a qualified service person to perform this work.
- **Do not dispose this product as unsorted municipal waste. Collection of such waste separately for special treatment is necessary.**
- **Keep far away from high-frequency equipment.**
- **Keep away from the following places:**
a place where it is full of oil gas; places where salty air surrounding (near the coast); a place where is caustic gas (the sulfide in hot spring). Location in the following places may cause malfunction or shorten the life span of the machine.
- **In the case of extremely strong wind, please prevent the air from flowing backwards into the outdoor unit.**
- **Snow canopy is necessary in snowfall places on the outdoor unit. Please consult the local dealer for details.**
- **In the frequent thunderstruck place, lightning proof actions should be taken.**
- **To prevent refrigerant leak, contact your dealer.**
When the system is installed and runs in a small room, it is required to keep the concentration of the refrigerant, if by any chance coming out, below the limit. Otherwise, oxygen in the room may be affected, resulting in a serious accident.
- **The refrigerant in the air conditioner is safe and normally does not leak.**
If the refrigerant leaks in the room, contact with a fire of a burner, a heater or a cooker may result in a harmful gas.
- **Turn off any combustible heating devices, ventilate the room, and contact the dealer where you purchased the unit.**
Do not use the air conditioner until a service person confirms that the portion where the refrigerant leaks is repaired.
- **The water system is crucial for ensuring the reliable operation of the unit. It is important to follow the installation requirements outlined in the instruction manual to avoid damage to the unit. Please note that the company cannot be held responsible for any damage caused by failure to meet these requirements.**



CAUTION

- **Do not use the air conditioner for other purposes.**
In order to avoid any quality deterioration, do not use the unit for cooling precision instruments, food, plants, animals or works of art.
- **Before cleaning, be sure to stop the operation, turn the breaker off or pull out the supply cord.**
Otherwise, an electric shock and injury may result.
- **In order to avoid electric shock or fire, make sure that an earth leak detector is installed.**
- **Be sure the air conditioner is grounded.**
In order to avoid electric shock, make sure that the unit is grounded and that the earth wire is not connected to gas or water pipe, lightning conductor or telephone earth wire.
- **In order to avoid injury, do not remove the fan guard of the outdoor unit.**
- **Do not operate the air conditioner with a wet hand.**
An electric shock may happen.
- **Do not touch the heat exchanger fins.**
These fins are sharp and could result in cutting injuries.
- **After a long use, check the unit stand and fitting for damage.**
If damaged, the unit may fall and result in injury.
- **To avoid oxygen deficiency, ventilate the room sufficiently if equipment with burner is used together with the air conditioner.**
- **Arrange the drain hose to ensure smooth drainage.**
Incomplete drainage may cause wetting of the building, furniture etc.
- **Never expose little children, plants or animals directly to the air flow.**
Adverse influence to little children, animals and plants may result.
- **Notice to avoid places where operation noise may easily be spread away or be enhanced.**
- **Noise can be amplified by anything blocking the air outlet of outdoor unit.**
- Choose a proper place that the noise and hot or cold wind blown out of the outdoor unit will not bring inconvenience to your neighbors and not affect the growth or animal or plant.
- Recommending locate and operate the equipment at the altitude height not exceeded than 1000m.

- Endurable temperature during transportation is $-25^{\circ}\text{C}\sim 55^{\circ}\text{C}$. Such equipment could endure 70°C of the maximum temperature in 24hrs.
- Do not allow a child to mount on the outdoor unit or avoid placing any object on it.
Falling or tumbling may result in injury.
- Do not operate the air conditioner when using a room fumigation - type insecticide.
Failure to observe could cause the chemicals to become deposited in the unit, which could endanger the health of those who are hypersensitive to chemicals.
- Do not place appliances which produce open fire in places exposed to the air flow from the unit or under the indoor unit.
It may cause incomplete combustion or deformation of the unit due to the heat.
- Do not install the air conditioner at any place where flammable gas may leak out.
If the gas leaks out and stays around the air conditioner, a fire may break out.
- The appliance is not intended for use by young children or infirm persons without supervision.
- Young children should be supervised to ensure that they do not play with the appliance.

2. TRANSPORTATION

■ Handling of the unit

The angle of inclination should not be more than 15° when carrying the unit, to avoid overturn of the unit.

a. Rolling handling: several rolling rods of the same size are placed under the base of the unit, and the length of each rod must be more than the outer frame of the base and suitable for balancing of the unit.

b. Lifting: the strength lifting rope (belt) can bear should be 4 times the weight of the unit. Check the lifting hook and ensure that it is firmly attached to the unit, and the lifting angle should be more than 60° . To avoid damages to the unit, the contact position of the unit and lifting rope should be provided with an at least 50mm thick wood block, cloth or hard paper. Any person is not allowed to stand below the unit when lifting it.

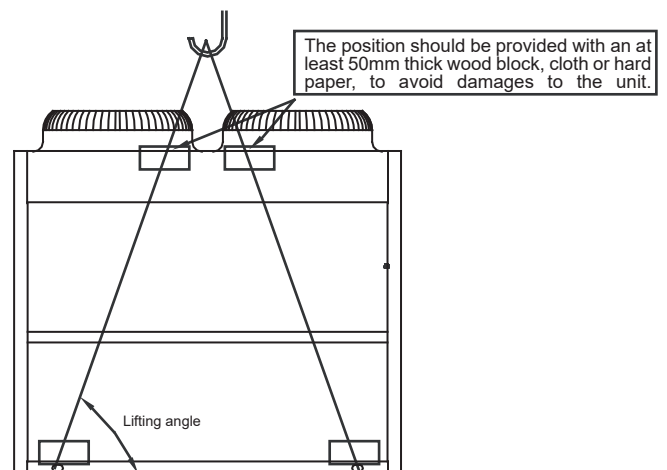
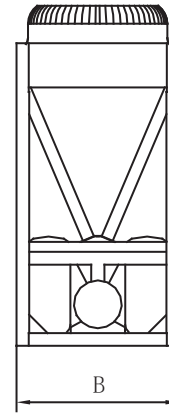

Fig. 2-1 Lifting of the unit

3. INSTALLATION OF THE UNIT

3.1 Selection of installation sites

- 3.1.1 The unit can be installed on the ground or on the suitable roof, but enough ventilation volume should be ensured in both cases.
- 3.1.2 The unit should not be installed where noise and vibration are required to a certain extent.
- 3.1.3 The installed unit should be sheltered from direct sunlight as much as possible, and be far away from boiler flues and ambient air which may erode condenser coils and copper tube parts of the unit.
- 3.1.4 If the installed unit can be approached by unauthorized persons, safety measures of isolation should be taken, such as rail guards. These measures will avoid artificial damages and accidental damages, and prevent the control boxes from being opened leading to exposure of electric components in operation.
- 3.1.5 The height of the installation foundation for the unit should not be less than 300mm, and floor drains are required in installation sites, to ensure smooth drainage and remove any seepers.
- 3.1.6 In case of installation on the ground, the steel base of the unit should be located on the concrete foundation, and the concrete plinth should extend below frozen soil layer. The foundation of the unit should not be connected to the foundation of the building, to avoid affecting the people due to transfer of noise and vibration. The base of the unit is provided with installation holes, which can be used to connect the unit and the foundation firmly.
- 3.1.7 In case of installation on the roof, the roof must possess enough strength to sustain weight of the unit and maintenance personnel. The unit can be supported on concrete foundations or channel steel frames similar to those used in the unit installation on the ground. The load-bearing channel steel must be in alignment with the installation holes of the unit damper, and the channel steel should possess enough width for installing the damper.
- 3.1.8 Consult the building contractor, the architectural designer or other specialists about the cases with special installation requirements.



Left view

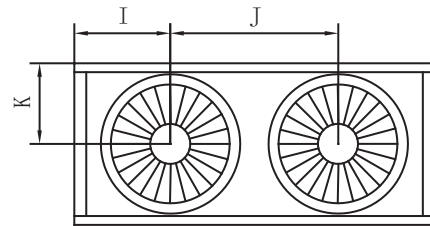

Top view

Fig. 3-1

Table 3-1

Model	MGBT-F60W/RN1
A	2000
B	900
C	1880
D	350
E	1420
F	225
G	1500
H	506
I	530
J	930
K	450



NOTE

The selected installation site of the unit should facilitate connection of water pipes and wires, and be free from water inlet of oil fume, steam or other heat sources. Besides, the noise of the unit and cold and hot air should not influence the surrounding environment.

3.2 Outline dimensional drawing

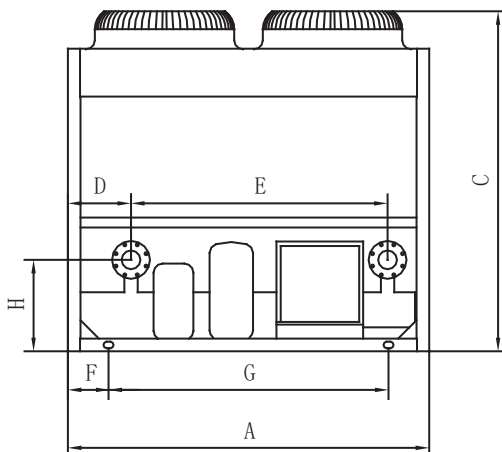

Front view



NOTE

- After installing the spring damper, the total height of the unit will increase by 135mm or so.
- The ports of inlet and outlet pipes should be flange ports, and flanges should be hubbed slip-on-welding steel pipe flanges.

3.3 Requirements of arrangement space of the unit

3.3.1 Requirements of arrangement space of the unit

3.3.1.1 To ensure adequate airflow entering the condenser, the influence of descending airflow caused by the high-rise buildings around upon the unit should be taken into account when installing the unit.

3.3.1.2 If the unit is installed where the flowing speed of air is high, such as on the exposed roof, the measures including sunk fence and Persian blinds can be taken, to prevent the turbulent flow from disturbing the air entering the unit. If the unit needs to be provided with sunk fence, the height of the latter should not be more than that of the former; if Persian blinds are required, the total loss of static pressure should be less than the static pressure outside the fan. The space between the unit and sunk fence or Persian blinds should also meet the requirement of the minimum installation space of the unit.

3.3.1.3 If the unit needs to operate in winter, and the installation site may be covered by snow, the unit should be located higher than the snow surface, to ensure that air flows through the coils smoothly.

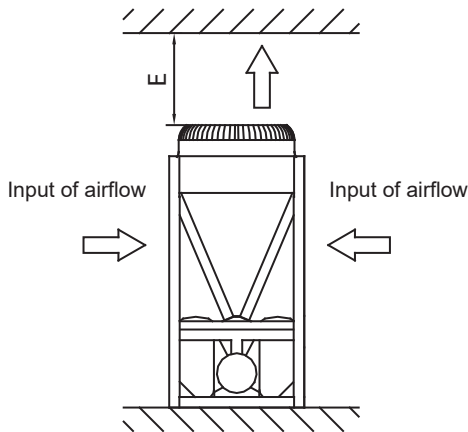
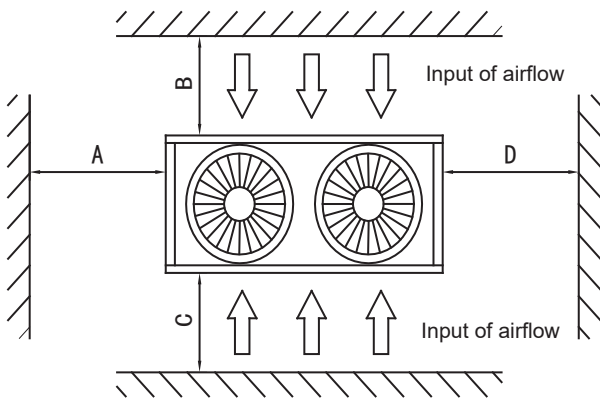

Fig. 3-2

Table 3-2

Installation space (mm)	
A	≥1500
B	≥2000
C	≥2000
D	≥1500
E	≥8000

3.4 Space requirements for parallel installation of multiple scroll units

To avoid back flow of the air in the condenser and operational faults of the unit, the parallel installation of multiple scroll units can follow the direction A and D as shown in Fig. 3-2, the spaces between the unit and the obstacle are given in Table 3-1, and the space between adjacent scroll units should not be less than 300mm; the installation can also follow the direction B and C as shown in Fig. 3-2, the spaces between the unit and the obstacle are given in Table 3-1, and the space between adjacent scroll units should not be less than 600mm; the installation can also follow the direction combination of A and D, and B and C, the spaces between the unit and the obstacle are given in Table 3-1, the space between adjacent scroll units in the direction A and D should not be less than 300mm, and the space between adjacent scroll units in the direction B and C should not be less than 600mm. If the spaces mentioned above cannot be met, the air passing from the unit to the coils may be restricted, or back flow of air discharge may occur, and the performance of the unit may be affected, or the unit may fail to operate.

3.5 Installation foundation

- The unit should be located on the horizontal foundation, the ground floor or the roof which can bear operating weight of the unit and the weight of maintenance personnel. Refer to Table 9.1 (Table of applicable models and parameters) for operating weight.
- If the unit is located so high that it is inconvenient for maintenance personnel to conduct maintenance, the suitable scaffold can be provided around the unit.
- The scaffold must be able to bear the weight of maintenance personnel and maintenance facilities.
- The bottom frame of the unit is not allowed to be embedded into the concrete of installation foundation.

3.5.1 Location drawing of installation foundation of the unit: (unit: mm)

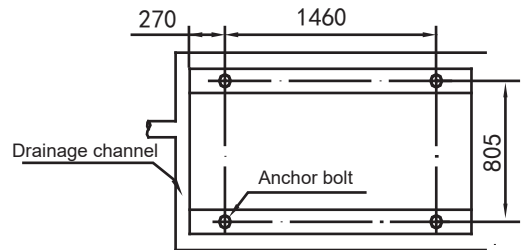

Schematic diagram of installation dimension of the unit

Fig. 3-3

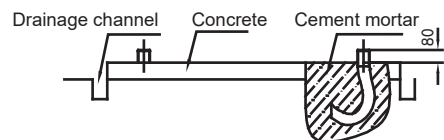

Fig. 3-4

3.6 Installation of damping devices

3.6.1 Damping devices must be provided between the unit and its foundation.

By means of the $\Phi 15\text{mm}$ diameter installation holes on the steel frame of the unit base, the unit can be fastened on the foundation through the spring damper. See Fig.3-3(Schematic diagram of installation dimension of the unit) for details about center distance of the installation holes. The damper does not go with the unit, and the user can select the damper according to the relevant requirements. When the unit is installed on the high roof or the area sensitive to vibration, please consult the relevant persons before selecting the damper.

3.6.2 Installation steps of the damper

- Step 1. Make sure that the flatness of the concrete foundation is within $\pm 3\text{mm}$, and then place the unit on the cushion block.
- Step 2. Raise the unit to the height suitable for installation of the damping device.
- c. Remove the clamp nuts of the damper.
- Step 3. Place the unit on the damper, and align the fixing bolt holes of the damper with the fixing holes on the unit base.
- Step 4. Return the clamp nuts of the damper to the fixing holes on the unit base, and tighten them into the damper.
- Step 5. Adjust the operational height of the damper base, and screw down the leveling bolts. Tighten the bolts by one circle to ensure equal height adjustment variance of the damper.
- Step 6. The lock bolts can be tightened after the correct operational height is reached.

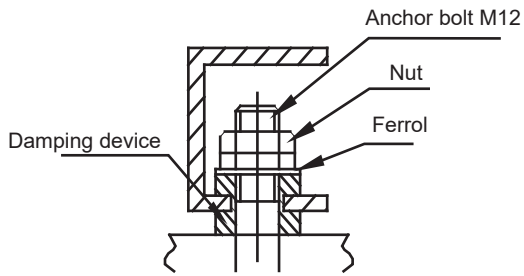
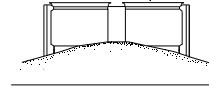

Fig. 3-5

3.7 Installation of device to prevent snow build-up and strong breeze

When installing an air-cooled heat pump chiller in a place with heavy snow, it is necessary to take snow protection measures to ensure trouble-free operation of the equipment. Otherwise, accumulated snow will block the air flow and may cause equipment problems.

(a) Buried in the snow



(b) Snow accumulated on the top plate

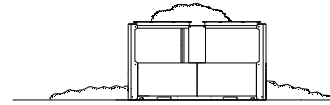

(c) Snow falling on the equipment

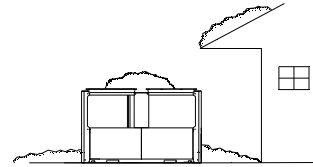

(d) Air inlet blocked by snow



(e) Equipment covered with snow

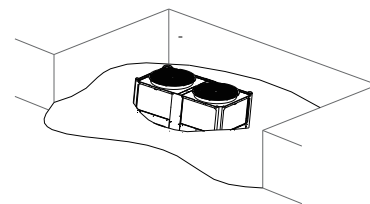

Fig. 3-6 Types of problems caused by snow

3.7.1 Measures used to prevent problems caused by snow

1) Measures to prevent build-up of snow

The base height should be at least the same as the predicted snow depth in the local area.

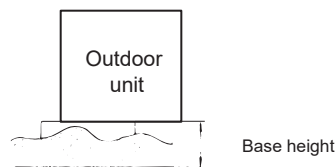

Fig. 3-7 Snow prevention base height

2) Lightning protection and snow protection measures

Check the installation site thoroughly; do not install the equipment under awnings or trees or a place where snow is piled up.

3.8.2 Precautions for designing a snow cover

1) To ensure a sufficient air flow required by the air-cooled heat pump chiller, design a protective cover to make the dust resistance 1 mm H₂O or less lower than the allowable external static pressure of air-cooled heat pump chiller.

2) The protective cover must be strong enough to withstand the snow weight and the pressure caused by strong wind and typhoon.

3) The protective cover must not cause short circuit of air discharge and suction.



NOTE

It is recommended that the damper should be fastened on the foundation with the provided holes. After the unit is placed on the foundation, the damper connected with the unit should not be moved, and the central clamp nut is not allowed to be tightened before the damper sustains load.

4. WATER SYSTEM INSTALLATION

4.1 Basic requirements of connection of chilled water pipes



CAUTION

- After the unit is in place, chilled water pipes can be laid.
- The relevant installation regulations should be abided with when conducting connection of water pipes.
- The pipelines should be free of any impurity, and all chilled water pipes must conform to local rules and regulations of pipeline engineering.

- Connection requirements of chilled water pipes
 - a. All chilled water pipelines should be thoroughly flushed, to be free of any impurity, before the unit is operated. Any impurity should not be flushed to or into the heat exchanger.

- b. Water must enter the heat exchanger through the inlet; otherwise the performance of the unit will decline.

- c. The inlet pipe of the evaporator must be provided with a target flow controller, to realize flow-break protection for the unit. Both ends of the target flow controller must be supplied with horizontal straight pipe sections whose diameter is 5 times that of the inlet pipe. The target flow controller must be installed in strict accordance with "Installation & Regulation Guide for Target Flow Controller" (Figure 4.3~4.4). The wires of the target flow controller should be led to the electric cabinet through shielded cable (see Electric Controlling Schematic Diagram for details). The working pressure of the target flow controller is 1.0MPa, and its interface is 1 inch in diameter. After the pipelines are installed, the target flow controller will be set properly according to the rated water flow of the unit.

- d. The pump installed in the water pipeline system should be equipped with starter. The pump will directly press water into the heat exchanger of the water system.

- e. The pipes and their ports must be independently supported but should not be supported on the unit.

- f. The pipes and their ports of the heat exchanger should be easy to disassemble for operation and cleaning, as well as inspection of port pipes of the evaporator.

- g. The evaporator should be provided with a filter with more than 40 meshes per inch at site. The filter should be installed near to the inlet port as much as possible, and be under heat preservation.

- h. The by-pass pipes and by-pass valves as shown in Fig. 4-1 must be mounted for the heat exchanger, to facilitate cleaning of the outside system of water passage before the unit is adjusted. During maintenance, the water passage of the heat exchanger can be cut off without disturbing other heat exchangers.

- i. The flexible ports should be adopted between the interface of the heat exchanger and on-site pipeline, to reduce transfer of vibration to the building.

- j. To facilitate maintenance, the inlet and outlet pipes should be provided with thermometer or manometer. The unit is not equipped with pressure and temperature instruments, so they need to be purchased by the user.

- k. All low positions of the water system should be provided with drainage ports, to drain water in the evaporator and the system completely; and all high positions should be supplied with discharge valves, to facilitate expelling air from the pipeline. The discharge valves and drainage ports should not be under heat preservation, to facilitate maintenance.

- l. All possible water pipes in the system to be chilled should be under heat preservation, including inlet pipes and flanges of the heat exchanger.

m. The outdoor chilled water pipelines should be wrapped with an auxiliary heating belt for heat preservation, and the material of the auxiliary heat belt should be PE, EDPM, etc., with thickness of 20mm, to prevent the pipelines from freezing and thus cracking under low temperature. The power supply of the heating belt should be equipped with an independent fuse.

n. When the ambient temperature is lower than 2°C, and the unit will be not used for a long time, water inside the unit should be drained. If the unit is not drained in winter, its power supply should not be cut off, and the fan coils in the water system must be provided with three-way valves, to ensure smooth circulation of the water system when the anti-freezing pump is started up in winter.

o. The common outlet pipelines of combined units should be provided with mixing water temperature sensor.



WARNING

- For the water pipeline network including filters and heat exchangers, dreg or dirt may seriously damages the heat exchangers and water pipes.
- The installation persons or the users must ensure the quality of chilled water, and de-icing salt mixtures and air should be excluded from the water system, since they may oxidize and corrode steel parts inside the heat exchanger.

4.2 Connection drawing of pipeline system

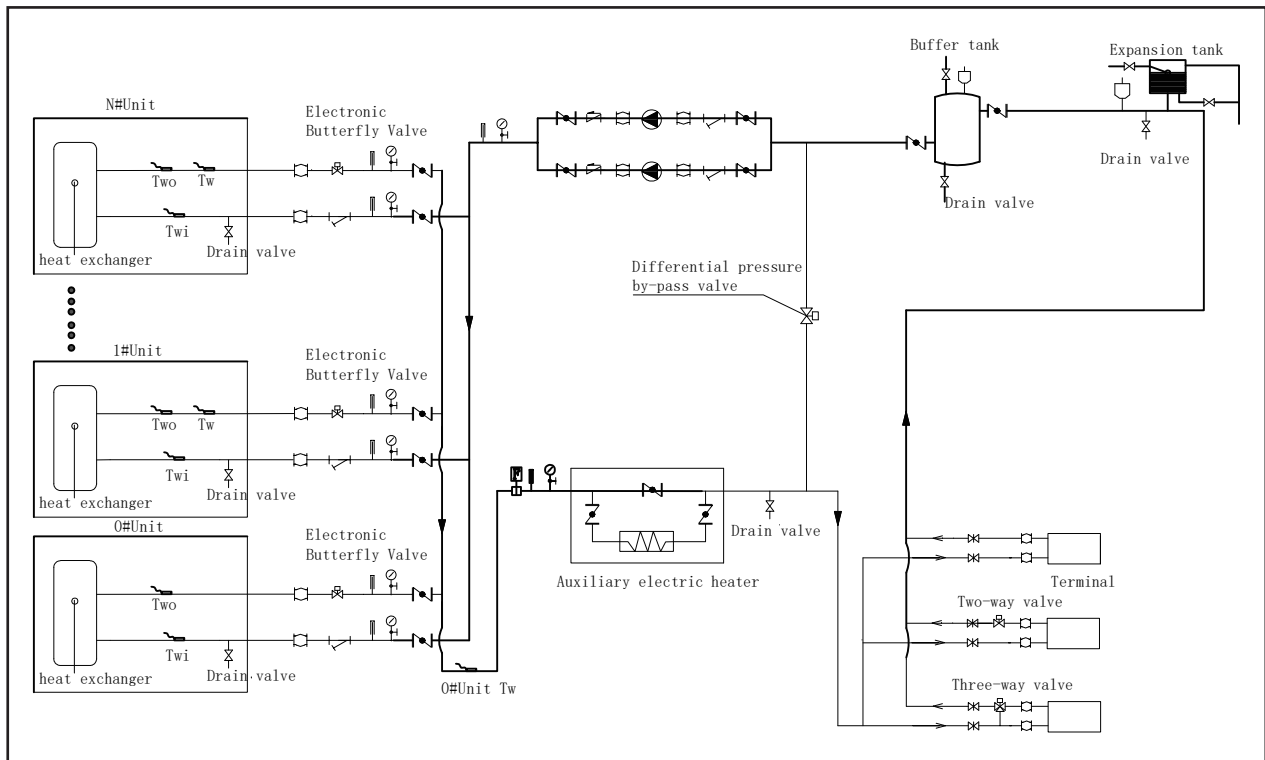

Symbol explanation				
Drain vavle	Water pressure instrument	Water flow switch	Gate valve	Differential pressure by-pass valve
Y-filter	Thermometer	Pump	Check valve	Atmospheric exhaust valve
Expansion tank	Safety valve	Soft joint	Solenoid three-way valve	

Fig. 4-1

4.3 Selection of buffer tank

The role of the buffer water tank:

In cooling mode, it prevents frequent opening and stopping of the equipment, thus protecting it.

The buffer water tank serves different purposes depending on whether the system is in cooling or heating mode. In heating mode, it ensures system stability during defrosting and reduces the need for frequent start-stop of the unit under small load conditions.

(1) Design calculation method

a. Calculation of defrosting time under heating conditions

The most significant factor affecting the air source heat pump heating system is the defrosting of the winter unit. To ensure thermal stability, the main engine's defrosting time should be limited to 4 minutes during winter operation. Additionally, the water temperature before and after defrosting should not decrease by more than 3 °C. The buffer tank's volume should be calculated based on the above data.

Heating conditions, minimum effective water capacity calculation:

$$M_H = [Q_h \times H_{min} \times T_H / (C \times \Delta T_H)] / \rho$$

Where:

M_H : minimum water capacity of the system, m³;

Q_h : rated heat production of the main engine, kW;

H_{min} : coefficient of defrosting ability, %; Generally take: 50%;

ΔT_H : Water temperature drop before and after defrosting, °C;

Conventional units generally take 3 °C;

C : specific heat gain of water 4.18 kJ/(kg·°C);

ρ : density of water, 1000 kg/m³;

T_H : defrosting time, S; Generally take 240S;

b. cooling running time calculation method

During the cooling process, avoid frequently opening and stopping the equipment to protect it. Ensure that there is enough water to allow the equipment to run continuously for at least 5 minutes.

Refrigeration conditions, the minimum effective water capacity calculation:

$$M_C = [Q_C \times C_A \times C_{min} \times T_c / (C \times \Delta T_c)] / \rho$$

Where:

M_C : minimum system water capacity, m³;

Q_C : cooling rated capacity, kW;

C_A : Capacity coefficient of small load condition: generally: 1.6.

C_{min} : the minimum operating capacity ratio of the unit, %;

Fixed frequency according to 100%; Frequency conversion unit according to 30%;

ΔT_c : Control temperature range, °C; Factory default 4 °C;

C : specific heat gain of water 4.18 kJ/(kg·°C);

ρ : density of water, 1000 kg/m³;

T_c : cooling operation time, S, generally 300S;

c. Calculate the system capacity according to the cooling and heating conditions, and take the maximum value;

$$M = \text{MAX}(M_H, M_C)$$

Single cooling unit takes M_C , single heating unit takes M_H ;

d. The effective water capacity of a water system refers to its total capacity, including the main pipeline, water storage tank, and the normally open end of the two-way valve involved in circulation during operation.

$$M_2 = V \times L$$

Where: M_2 : effective water capacity of water system, m³;

L : Total length of system pipeline, m;

V : Water capacity m³/m per meter pipe length of each model system pipeline.

e. Buffer tank volume refers to the minimum water capacity required to meet the normal operation of the unit:

$$V_{min} = M - M_2$$

V_{min} - Minimum volume of buffer tank, m³.

(2) Empirical Estimation Method

For renovation projects where the system water capacity cannot be estimated, the volume of the buffer tank can be estimated empirically using the following formula:

$$V_{min} = Q \times K$$

Here, V_{min} represents the minimum volume of the buffer tank in litres. The comfort air conditioning requires 10 L/kW and the process air conditioning requires 15L/kW. The stability of the system water temperature increases with a higher K value.

The main mechanism for heat is measured in kW.

(3) Precautions for buffer tank selection:

a. The configuration of the buffer tank depends on the specific project instance. If the water system capacity is large or the end form is in the form of floor heating, the buffer tank should not be added. However, increasing the size of the buffer water tank has several advantages for the system's operation. It helps to avoid frequent opening and stopping of the main engine under small load conditions, prevents defrosting of the main engine, and ensures that there is enough water in the system to meet the unit defrosting requirements. This improves the comfort of the unit. Therefore, it is necessary to comprehensively consider various factors on the site from an investment perspective.

b. There are two methods to calculate the volume of the buffer tank. The results differ, with method 1 being more accurate as it is based on actual operation data analysis. Therefore, it is recommended to use method 1 for actual design and selection. Method 2 is an empirical estimate.

c. When using multiple units in parallel, it is recommended to base the calculation on the maximum capacity of the parallel unit.



WARNING

Adequate system water capacity is a necessary condition to ensure reliable operation of equipment. Otherwise, it may cause frequent start and stop of the compressor, shorten the service life of the compressor, cause large fluctuations in defrosting water temperature during heating operation, and result in abnormal defrosting. When the water capacity of the accounting system is insufficient, the system must add a buffer water tank to meet the minimum water capacity requirements for equipment operation.

4.4 Minimum chilled water flow

The minimum chilled water flow is shown in the table 4-1

If the system flow is less than the minimum unit flow rate, the evaporator flow can be recirculated, as shown in the diagram.

For minimum chilled water flow rate

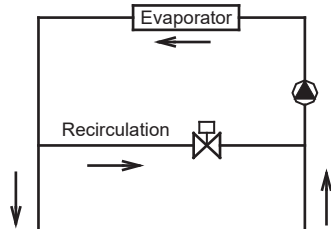

Fig. 4-2

4.5 Maximum chilled water flow

The maximum chilled water flow is limited by the permitted pressure drop in the evaporator. It is provided in the table 4-1

If the system flow is more than the maximum unit flow rate, bypass the evaporator as shown in the diagram to obtain a lower evaporator flow rate.

For maximum chilled water flow rate

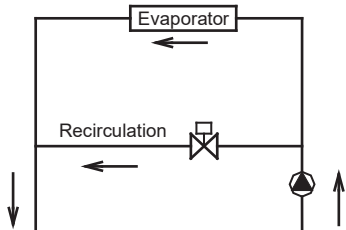

Fig. 4-3

4.6 Minimum and Maximum water flow rates

Table 4-1

Item	Water flow rate(m ³ /h)	
	Minimum	Maximum
MGBT-F60W/RN1	9.27	11.33

4.7 Water Pump Selection and Installation

4.7.1 Water Pump Selection Requirements

- The external linkage water pump must be controlled by the host logic program and the signal should be linked with the external water pump control cabinet.
- The water pump should be installed on the inlet pipe of the unit, and the inlet/outlet pipe diameter of the water pump should be the same as the main water pipe diameter. The inlet and outlet interfaces of the water pump should be connected softly, and the foundation should have vibration damping measures. The pump should be installed outdoors with rain, sun, and frost protection measures.
- The selected pump power should meet the required flow/head performance curve at any point and ensure that there are no humps or inflection points in the working area. Standby pumps should be set up, with at least one backup pump, to ensure that the water system remains operational during maintenance and replacement of pumps. The standby pumps should be of the same type as the primary pumps, and no more than three units should be in operation at any given time.
- If the head of a pump cannot meet the water pressure requirements at the most unfavorable points, tandem pumps can be used to increase the head while keeping the flow rate constant. If the flow rate of a single pump cannot meet the flow rate requirements at the most unfavorable points, parallel pumps can be used to increase the flow rate of the entire system while maintaining the same pressure at the water pump outlet.

4.7.2 Calculation of water pump selection

(1) Flow rate selection calculation

For the primary pump system, the water pump's rated flow rate should be equal to or greater than the unit's rated flow rate. In parallel mode, the water pump's rated flow rate should be equal to or greater than the sum of the rated flow rates of the parallel units. The secondary pump system requires a host side circulating pump flow (L1) that is equal to or greater than the unit's rated flow. The end user side circulating pump flow (L2) can be calculated using the following formula:

$$L2 = (1.1 \sim 1.2) \times (Q \times 0.86 / \Delta T)$$

L2- circulating water flow m³/h

Q - Total terminal load kW

ΔT - Temperature difference of inlet and return water at the end °C

(2) Head selection calculation

Primary pump system, pump head: $H = H1 + H2$

On the host side: $H1 = (h11 + h12) \times (1.1 \sim 1.2)$

Terminal side: $H2 = (h21 + h22) \times (1.1 \sim 1.2)$

Where:

h11-- water resistance of main engine, unit: m

h12-- the most unfavorable water pipe resistance on the main engine side, unit: m. Including the sum of water pipe resistance and various valve body resistance;

h21-- end water resistance, unit: m

h22-- the most adverse pipe resistance on the end side, unit: m. Including water pipe resistance and the sum of various valve resistance;

The calculation method for the head of the secondary pump system should take into account the head of the primary pump, the H1 head of the host-side circulating water pump for unit water resistance and piping water resistance, the height difference between the tank and the host, and the open water system. It is recommended that the total head value should not be less than 18 meters. For open systems, the height difference between the tank and the host must be considered when dealing with the user-side circulating water pump head H2, which is subject to the end of the water resistance and the most unfavorable loop water resistance.

4.8 Water Quality Requirements

When using urban tap water for hot and cold water, scale buildup is rare. However, when using well water or river water, more scale, sand, and other sediments are produced. Therefore, it is necessary to filter and soften this water with water softening equipment before it flows into the hot and cold water system. Sand and soil settling in the water-side heat exchanger can block the circulation of hot and cold water, leading to freezing accidents. To prevent scaling and corrosion of equipment, it is important to analyze the water quality before use, including factors such as pH value, conductivity, chloride ion concentration, and sulfur ion concentration.

Water quality standards applicable to the unit

Table 4-2

test item	units	permissible value
pH(25℃)	/	7.5~8.0
turbidity	NTU	≤3
Conductivity(25℃)	μS/cm	≤200
Chloride ion	mg/L	≤50
Iron content	mg/L	≤0.3
calcium hardness	mg/L	≤80
total alkalinity	mg/L	≤200

test item	units	permissible value
Dissolved Oxygen	mg/L	not detectable
turbidity	mg/L	not detectable
Organophosphorus (P)	mg/L	not detectable
Sulfide ion	mg/L	≤50
acid consumption	mg/L	≤50
Sulfide ion	mg/L	not detectable
Ammonium ion	mg/L	not detectable
silicon dioxide	mg/L	≤30



WARNING

Water quality is crucial to ensure the normal and reliable operation of equipment, otherwise it may cause damage to the unit casing or reduce its lifespan. Therefore, it is necessary to ensure that the water quality meets the requirements of equipment use.

4.9 Installation & regulation guide for target flow controller

4.9.1 Please carefully check flow switches before conducting installation of the target flow controller. Packing should be in good condition, and the appearance should be free of damage and deformation. If any problem, please contact the manufacturer.

4.9.2 Flow switches can be installed in the horizontal pipeline or the vertical pipeline with upward flowing direction but cannot be mounted in the pipeline with downward flowing direction. The inlet water of gravity should be taken into account when flow switches are installed in the pipeline with upward flowing direction.

4.9.3 Target flow controller must be installed on a section of straight-line pipeline, and its both ends must be supplied with straight-line pipes whose length is at least 5 times diameter of the pipe. In the meanwhile, the fluid flowing direction in the pipeline must be consistent with the direction of arrow on the controller. The connection terminal should be located where wiring connection can be easily done.

4.9.4 Pay attention to the following items when conducting installation and wire connection:

- a. Collision of the wrench with the soleplate of the flow switch is prohibited, since such collision may cause deformation and failure of the flow switch.
- b. To avoid electric shock and damages to the devices, the power supply should be cut off, when wires are connected or adjustment is done.
- c. When wiring connection is conducted, adjustment of other screws except connection terminals of micro switches and ground screws is prohibited. In the meanwhile, over great force should not be applied when wires of micro switches are connected, otherwise micro switches may suffer displacement, thus leading to failure of flow switches.

d. Special grounding screws should be used for earth connection. Bolts should not be installed or removed at will; otherwise flow switches may suffer deformation and failure.

e. Flow switches have been set at minimal flow value prior to ex-factory. They should not be adjusted below the ex-factory setting value, or they may suffer failure. After installing flow switches, please press the flow switch lever several times to check them. When the lever is found not to respond with "clatter", rotate the screw in a clockwise direction, until "clatter" occurs.

f. Be sure to determine the model of target slice according to the rated flow of the unit, the diameter of the outlet pipe and the adjustment range of the target slice of the flow switch. Besides, the target slice should not contact with other restrictors in the pipeline or on the inner wall of the pipeline, or the flow switch cannot be reset normally.

4.5.5 Determine whether the flow switch and the system connected with it are in good operation according to the measured value by flow meter, namely, when the measured value on flow meter is less than 60% of rated water flow of the unit, the target flow controller should be cut off and observed for 3 working periods, and it should be covered with flow switch shell timely.

● Schematic diagram of target flow controller

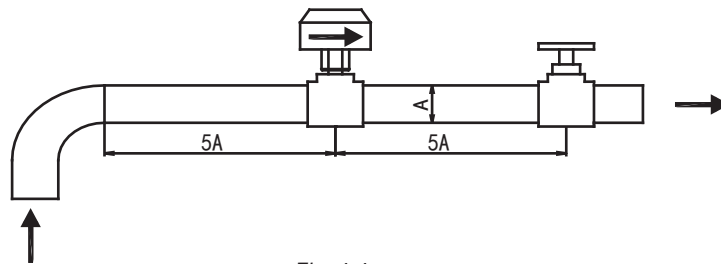

Fig. 4-4

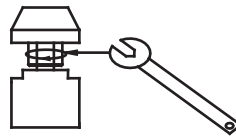

Fig. 4-5

4.10 Installation of single-module water system pipeline

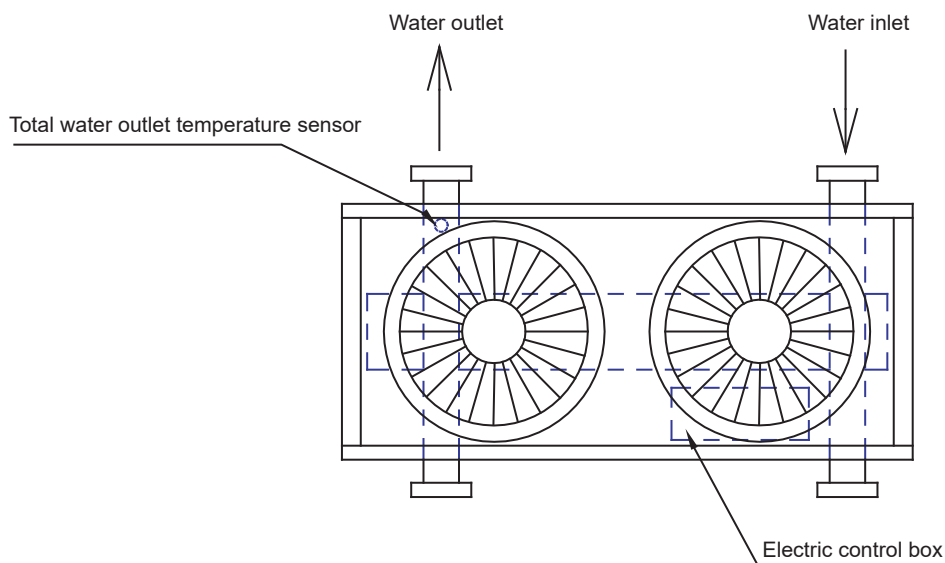

Fig. 4-6

4.11 Installation of multi-module water system pipeline

Multi-module combination installation involves special design of the unit, so relevant explanation is given as follows.

4.11.1 Installation mode of multi-module combination water system pipeline

a. Installation mode I (recommended installation mode)

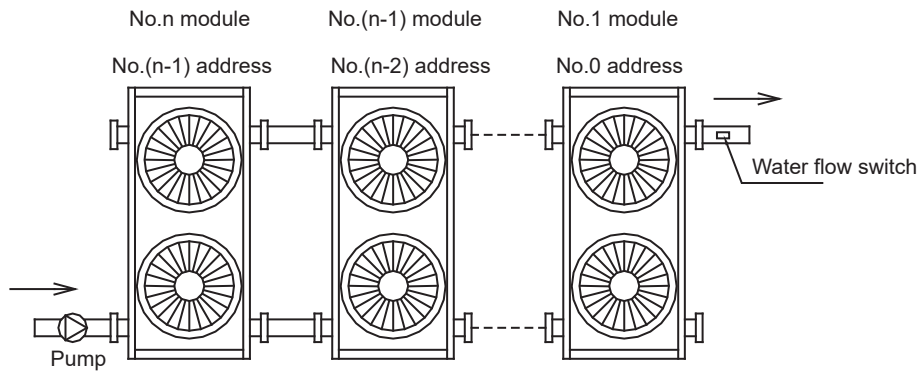

Fig.4-7 (less than 6 modules)

b. Installation mode II (recommended installation mode)

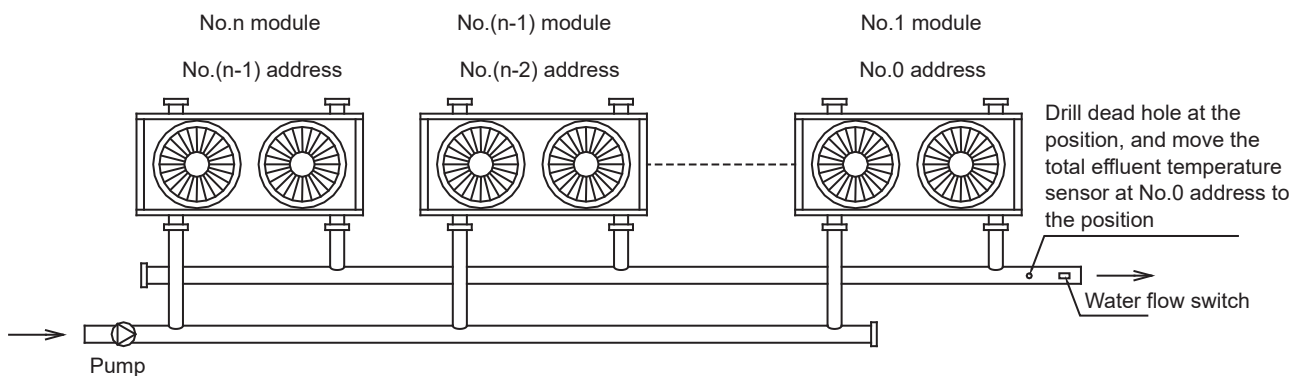

Fig.4-8 (installation mode A: less than 16 modules)

c. Installation mode III

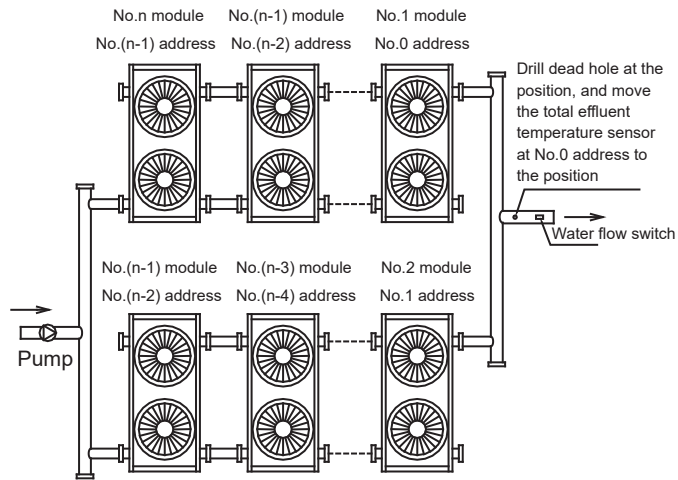

Fig.4-9 (installation mode A: less than 16 modules)

d. Installation mode IV

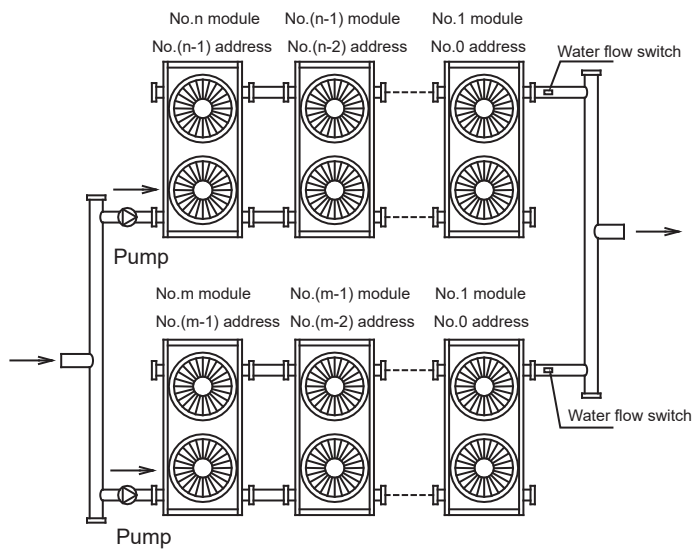

Fig.4-10 (installation mode A: less than 16 modules)

4.12 Pipe diameter selectio

4.12.1 Pipe diameter calculation

Table 4-3

Pipe diameter/flow rate/flow table

pipe diameter (DN)	Q m ³ /h													
	0.4m/s	0.6m/s	0.8m/s	1.0m/s	1.2m/s	1.4m/s	1.6m/s	1.8m/s	2.0m/s	2.2m/s	2.4m/s	2.6m/s	2.8m/s	3.0m/s
20	0.5	0.7	0.9	1.1	1.4	1.6	1.8	2.0	2.3	2.5	2.7	2.9	3.2	3.4
25	0.7	1.1	1.4	1.8	2.1	2.5	2.8	3.2	3.5	3.9	4.2	4.6	4.9	5.3
32	1.2	1.7	2.0	2.9	3.5	4.1	4.6	5.2	5.8	6.4	6.9	7.5	8.1	8.7
40	1.8	2.7	3.6	4.5	5.4	6.3	7.2	8.1	9.0	10.0	10.9	11.8	12.7	13.6
50	2.8	4.2	5.7	7.1	8.5	9.9	11.3	12.7	14.1	15.6	17.0	18.4	19.8	21.2
65	4.8	7.2	9.6	11.9	14.3	16.7	19.1	21.5	23.9	26.3	28.7	31.1	33.4	35.8
80	7.2	10.9	14.5	18.1	21.7	25.3	29.0	32.6	36.2	39.8	43.4	47.0	50.7	54.3
100	11.3	17.0	22.6	28.3	33.9	39.6	45.2	50.9	56.5	62.2	67.9	73.5	79.2	84.8
125	17.7	26.5	35.3	44.2	53.0	61.9	70.7	79.5	88.4	97.2	106.0	114.9	123.7	132.5
150	25.4	38.2	50.9	63.6	76.3	89.1	101.8	114.5	127.2	140.0	152.7	165.4	178.1	190.9
200	45.2	67.9	90.5	113.1	135.7	158.3	181.0	203.6	226.2	248.8	271.4	294.1	316.7	339.3
250	70.7	106.0	141.4	176.7	212.1	247.4	282.7	318.1	353.4	388.8	424.1	459.5	494.8	530.1
300	101.8	152.7	203.6	254.5	305.4	356.3	407.1	458.0	508.9	559.8	610.7	661.6	712.5	763.4
350	138.5	207.8	277.1	346.4	415.6	484.9	554.2	623.4	692.7	762.0	831.3	900.5	969.8	1039.1
400	181.0	271.4	361.9	452.4	542.9	633.3	723.8	814.3	904.8	995.3	1085.7	1176.2	1266.7	1357.2
450	229.0	343.5	458.0	572.6	687.1	801.6	916.1	1030.6	1145.1	1259.6	1374.1	1488.6	1603.2	1717.7
500	282.7	424.1	565.5	706.9	848.2	989.6	1131.0	1272.3	1413.7	1555.1	1696.5	1837.8	1979.2	2120.6
600	407.1	610.7	814.3	1017.9	1221.4	1425.0	1628.6	1832.2	2035.7	2239.3	2442.9	2646.5	2850.0	3053.6

Table 4-4

pipe diameter (DN)	Recommended flow rate m/s														
	20	25	32	40	50	65	80	100	125	150	200	250	300	350	400
closed system	0.5-0.6	0.6-0.7	0.7-0.9	0.8-1	0.9-1.2	1.1-1.4	1.2-1.6	1.3-1.8	1.5-2.0	1.6-2.2	1.8-2.5	1.8-2.6	1.9-2.9	1.6-2.5	1.8-2.6
open system	0.4-0.5	0.5-0.6	0.6-0.8	0.7-0.9	0.8-1.0	0.9-1.2	1.1-1.4	1.2-1.6	1.4-1.8	1.5-2.0	1.6-2.3	1.7-2.4	1.7-2.4	1.6-2.1	1.8-2.3

In the general engineering calculation, the water pipe pressure is usually 0.1 ~ 0.6MPa, and the flow rate of water in the water pipe is 1 ~ 3m/s, often 1.5m/s.

$$d = \sqrt{\frac{4Q}{3.14v}}$$

Where: Q(m³/s)---- water flow through the pipe section

d(m)---- inner diameter of the pipeline

v(m/s)---- Assumed water flow rate (Recommended water flow rate in pipe is shown below, in m/s)

If you need to calculate accurately, you should first assume the flow rate, and then calculate the Reynolds number according to the viscosity, density and pipe diameter of the water, and then calculate the resistance coefficient along the road from the Reynolds number, and the pipe fittings in the pipeline (such as tee, elbow, valve, reducer, etc.) are checked to find the equivalent pipe length. Finally, the pressure loss of the main pipe is calculated from the resistance coefficient along the path and the total length of the pipe (including the equivalent length of the pipe), and the actual flow rate is calculated according to Bernoulli formula, and the actual flow rate is calculated again according to the above process until both are close (iterative test algorithm). Therefore, it is rarely used in practice. The approximate flow data can be queried according to the above table and the pipe diameter can be selected.



NOTE

Hydraulic calculation must be performed after the selection of the main water pipe. If the resistance of the water line is greater than the lift of the selected pump, the larger pump must be selected again, or the water pipe must be increased by one size (see the following introduction for hydraulic calculation).

4.12.2 Select water main specifications

The following values refer to the main inlet and outlet water pipe, not the unit inlet and outlet water pipe. The data is for reference. Please refer to the actual project.

Table 4-5

Rated cooling capacity (kW)	Total inlet and outlet diameter	Rated cooling capacity (kW)	Total inlet and outlet diameter
25≤Q≤40	DN32	210<Q≤325	DN100
40<Q≤50	DN40	325<Q≤510	DN125
50<Q≤80	DN50	510<Q≤740	DN150
80<Q≤145	DN65	740<Q≤1300	DN200
145<Q≤210	DN80	1300<Q≤2080	DN250



CAUTION

Please pay attention to the following items when installing multiple modules:

- Each module corresponds to an address code which cannot be repeated.
- Main water outlet temperature sensing bulb, target flow controller and auxiliary electric heater are under control of the main module.
- One wired controller and one target flow controller are required and connected on the main module.
- The unit can be started up through the wired controller only after all addresses are set and the aforementioned items are determined. The wired controller is ≤500m away from the outdoor unit.

4.13 Design of the tank in the system

The expansion water tank is divided into two types:

open and closed. Its purpose is to maintain constant pressure and accommodate expansion water. The closed expansion water tank is also known as an expansion tank. The open expansion tank is connected to the atmosphere without pressure and is usually installed at the suction inlet of the circulating pump, which should be 1 to 2 meters higher than the highest point of the system. The water supply of the water tank is determined by the water level. In large systems, an expansion tank should be set up for the primary pump water system if it is not equipped with a buffer tank or heat storage tank in the open water system. In large systems, an expansion tank should be set up for the primary pump water system if it is not equipped with a buffer tank or heat storage tank in the open water system. The expansion tank should be arranged at the highest point of the water system to accommodate any excess water volume. The expansion tank, also known as a closed expansion tank, can be installed in the suction inlet of the circulating pump. It should not be connected to the atmosphere or pressure. If the room is far away, it is not necessary to connect the expansion tank to the room. In this case, the expansion tank can be connected to the outdoor return water main. When selecting the capacity of the expansion tank, ensure that specific terms, abbreviations, and symbols are used consistently once they have been introduced. This type of expansion tank uses constant pressure water supply and is commonly used in small systems.

Capacity selection of expansion tank:

$V = \text{system water capacity} \times \text{expansion coefficient} \times \text{safety margin}$

The expansion coefficient ranges from 1 to 3%, and the safety margin ranges from 1.1 to 1.2.

4.14 Capacity selection of auxiliary electric heater

1. Electric auxiliary heat use

When repairing certain units of the system or in the event of temporary faults (such as protection mechanisms), the system is opened as a backup. It is important to ensure that the system can maintain water temperature and heat production even in harsh conditions of low ambient temperature, in order to compensate for any attenuation of heat production in the unit under such conditions.

2. Electric auxiliary thermal linkage control.

If the ambient temperature is too low for the unit to turn on or if the failure protection cannot be activated, the auxiliary heat heater will automatically turn on according to the water temperature control program. This ensures reliable operation of the customer's water and the unit.

3. Electric auxiliary thermal selection

The figure below demonstrates that when the design point and balance point are the same, the unit's total heat production is equal to the building's heat load. In this case, electric auxiliary heat is unnecessary.

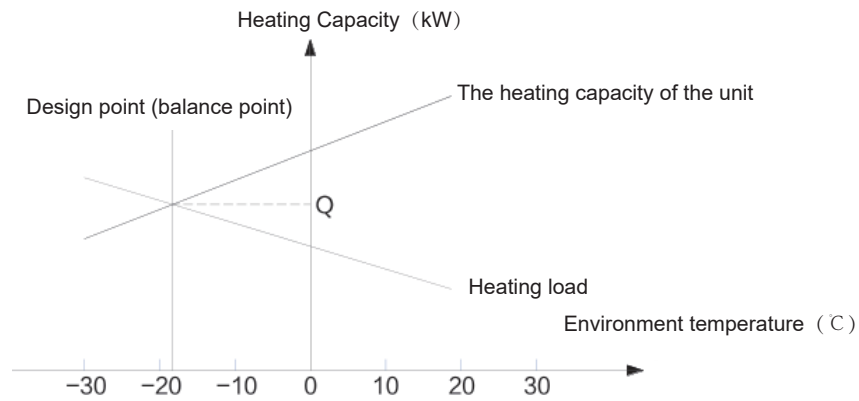

Fig. 4-11

If the design point and the balance point do not coincide, the heating capacity of the unit at the design point (Q2) will be less than the building heat load (Q1). In this case, electric heating must be configured with a power output equal to the difference between Q1 and Q2.

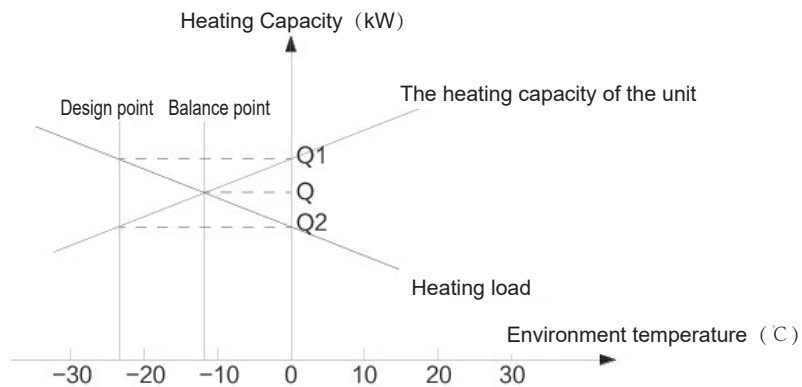

Fig. 4-12

5. ELECTRIC WIRING

5.1 Electric wiring



CAUTION

1. The air-conditioner should apply special power supply, whose voltage should conform to rated voltage.
2. Wiring construction must be conducted by the professional technicians according to the labeling on the circuit diagram.
3. Only use the electric components specified by our company, and require installation and technical services from the manufacturer or authorized dealer. If wiring connection fails to conform to electric installation norm, failure of the controller, electronic shock, and so on may be caused.
4. The connected fixed wires must be equipped with full switching-off devices with at least 3mm contact separation.
5. Set leakage protective devices according to the requirements of national technical standard about electric equipment.
6. After completing all wiring construction, conduct careful check before connecting the power supply.
7. Please carefully read the labels on the electric cabinet.
8. The user's attempt to repair the controller is prohibited, since improper repair may cause electric shock, damages to the controller, and so on. If the user has any requirement of repair, please contact the maintenance center.

5.2 Power supply specification

Table 5-1

Model	Item	Outdoor power supply			
		Power supply	Manual switch	Fuse	Wiring
MGBT-F60W/RN1		380-415V 3N~50Hz	100A	70A	25mm ² (<20m)

5.3 Requirements of wiring connection

5.3.1 No additional control components are required in the electric cabinet (such as relay, and so on), and the power supply and control wires not connected with the electric cabinet are not allowed to go through the electric box. Otherwise, electromagnetic interference may cause failure of the unit and control components and even damages to them, which thus lead to protective failure.

5.3.2 All cables led to the electric box should be supported independently but by the electric box.

5.3.3 The strong current wires generally pass the electric box, and 220-230V alternating current may also pass the control board, so wiring connection should conform to the principle of separation of strong current and weak current, and the wires of power supply should be kept more than 100 mm away from the control wires.

5.3.4 Only use 380-400V 3N~50Hz rated power supply for the unit, and the maximum allowable range of voltage is 342V~440V.

5.3.5 All electric wires must conform to local wiring connection norm. The suitable cables should be connected to power supply terminal through wiring connection holes at the bottom of the electric cabinet. According to Chinese standard, the user is responsible for providing voltage and current protection for the input power supply of the unit.

5.3.6 All power supplies connected to the unit must pass one manual switch, to ensure that the voltages on all nodes of electric circuit of the unit are released when the switch is cut off.

5.3.7 The cables of correct specification must be used to supply power for the unit. The unit should use independent power supply, and the unit is not allowed to use the same power supply together with other electric devices, to avoid over-load danger. The fuse or manual switch of the power supply should be compatible with working voltage and current of the unit. In case of parallel connection of multiple modules, the requirements of wiring connection mode and configuration parameters for the unit are shown in the following figure.

5.3.8 Some connection ports in the electric box are switch signals, for which the user needs to provide power, and the rated voltage of the power should be 220-230VAC. The user must be aware that all power supplies they provided should be obtained through power circuit breakers (provided by the user), to ensure that all voltages on the nodes of the provided power supply circuit are released when the circuit breakers are cut off.

5.3.9 All inductive components provided by the user (such as coils of contactor, relay, and so on) must be suppressed with standard resistance-capacitance suppressors, to avoid electromagnetic interference, thus leading to failure of the unit and its controller and even damages to them.

5.3.10 All weak current wires led to the electric box must apply shielded wires, which must be provided with grounding wires. The shield wires and power supply wires should be laid separately, to avoid electromagnetic interference.

5.3.11 The unit must be provided with grounding wires, which are not allowed to be connected with the grounding wires of gas fuel pipelines, water pipelines, lightning conductors or telephones. Improper earth connection may cause electric shock, so please check whether earth connection of the unit is firm or not frequently.

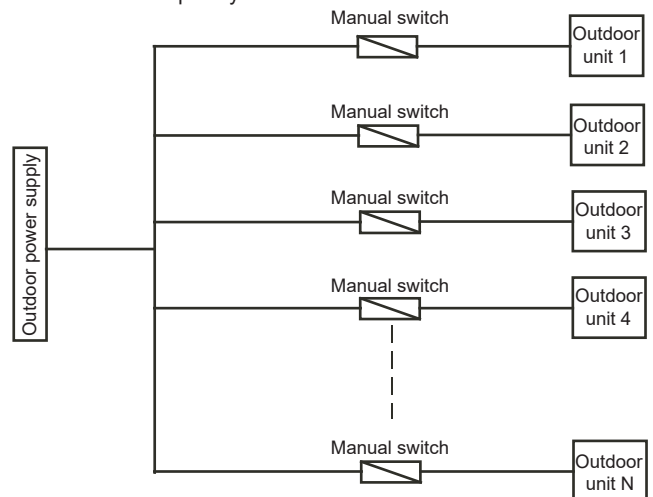

Fig. 5-1



NOTE

Only 16 scroll units can be combined at most.

5.4 Wiring steps

Step 1. Check the unit and ensure that it is connected with grounding wires correctly, to avoid leakage, and the grounding devices should be mounted in strict accordance with the requirements of electrical engineering rules. The grounding wires can prevent electric shock.

Step 2. The control box of the main power switch must be mounted in a proper position.

Step 3. Wiring connection holes of the main power should be provided with glue cushion.

Step 4. The main power and neutral wires and grounding wires of power supply are led into the electric box of the unit.

- Step 5. The wires of the main power must pass the bonding clamp.
- Step 6. Wires should be connected firmly to the connection terminals A, B, C and N.
- Step 7. Phase sequences must be consistent when the wires of the main power.
- Step 8. The main power should be located out of easy reach of non-professional maintenance personnel, to avoid mal-operation and improve safety.
- Step 9. Connection of control wires of water flow switches: the wire leads (prepared by the user) of water flow switches are connected to the connection terminals W1 and W2 of the main unit.
- Step 10. Connection of control wires of auxiliary electric heaters: the control wires of AC contactor of the auxiliary electric heater must pass the connection terminals H1 and H2 of the main unit, as shown in Fig. 5-2.
- Step 11. Connection of control wires of pump: the control wires of AC contactor of pump must pass the connection terminals p1 and P2 of the main unit, as shown in Fig. 5-3.
- Step 12. The connection way of the wire controller connects with every signal wires from package units: signal wires P, Q, E are connected in the same way of main wires connection method and accordingly connect to the terminals P, Q, E in the wire controller.

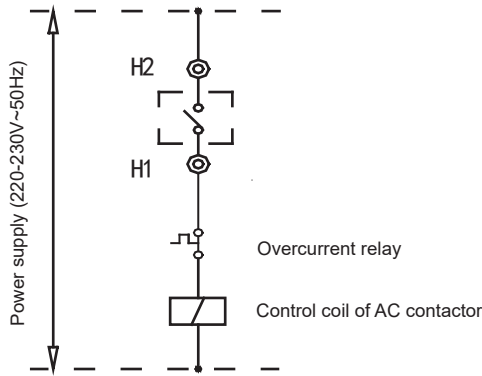

Fig. 5-2

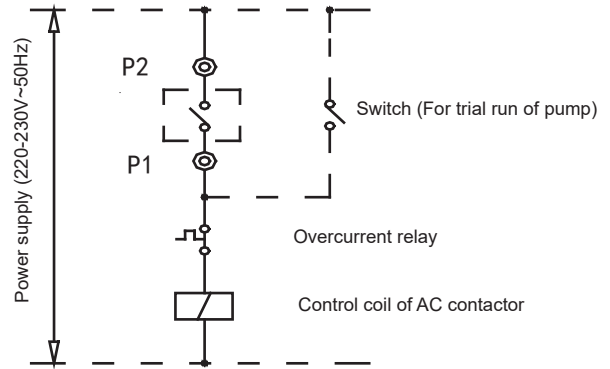

Fig. 5-3

5.5 Electric control schematic diagram of the unit

- 5.5.1 Electric control diagram of the main unit and subordinate units (see Attached Drawing (I))
- 5.5.2 Schematic diagram of connection and communication of the main unit and subordinate units (see Attached Drawing (II))
- 5.5.3 Indicating diagram of electric control of main control board (see Fig. 5-4)

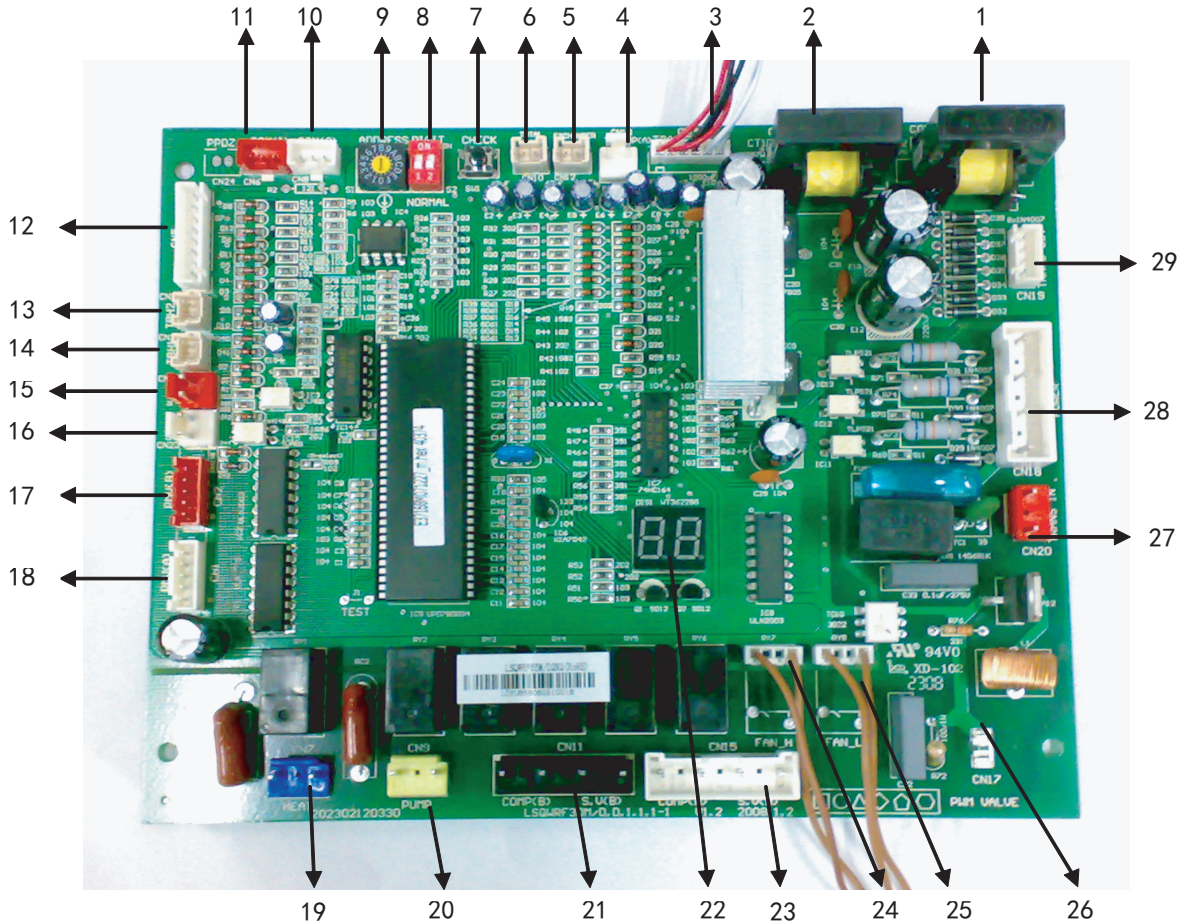
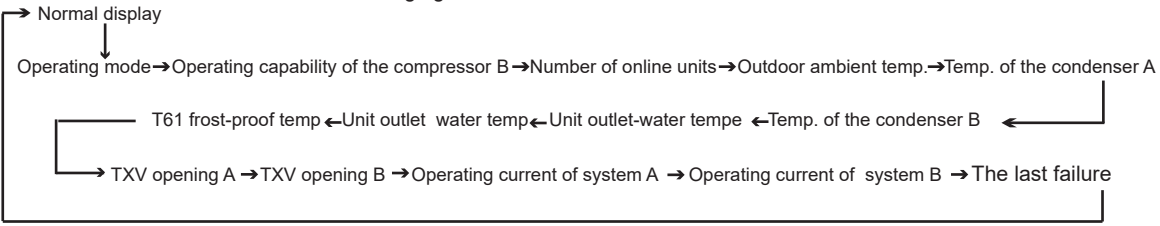





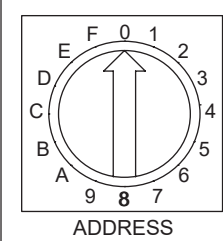
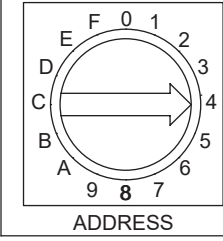

Fig. 5-4

5.6 Detail description for parts in fig. 5-4

Table 5-2

No.	Detail information				
1	Detection of current of the compressor B (protection code P5)				
2	Detection of current of the compressor A (protection code P4) Current is not detected within the initial 5 seconds after the compressor is started up. When the current of the compressor is detected to exceed protective value set (33A for constant speed compressor), it will be shut down and re-started after 3 min.				
3	<p>T4: outdoor ambient temperature sensor (fault code E7) T3B: pipe temperature sensor of the condenser B (fault code E6 and protection code P7) T3A: pipe temperature sensor of the condenser A (fault code E5 and protection code P6)</p> <p>1) T4: if there is one system that requires starting outdoor fans, the fans are started through electric control of the unit. Start outdoor fan A only, start A and B gears, and control the unit through T4. 2) T3B and T3A: when the electric control of the scroll unit detects the temperature of the outdoor pipe T3A or T3B of the system exceeds the protective temperature 65° C, the corresponding system will be shut down. And it will be re-started up, after the temperature drops below the recovery temperature 60° C. Another system will be not affected. 3) T4, T3B and T3A: when the temperature sensor is detected to suffer open circuit or short circuit, fault alarm will occur.</p> <ul style="list-style-type: none"> • When the main unit suffer fault of temperature sensor: the main unit and subordinate units will be shut down. • When the subordinate unit suffer fault of temperature sensor: the unit will be shut down, but other subordinate units will not be affected. 				
4	(reserved)				
5	Unit outlet water temperature sensor (fault code E4) Under refrigeration mode and heating mode, conduct adjustment according to the magnitude of unit outlet water temperature. Adjustment range of constant speed capability: ON and OFF.				
6	Total outlet water temperature sensor (fault code E3) Only the main unit is valid, and the subordinate units are invalid. Under refrigerating mode and heating mode, conduct adjustment according to the magnitude of total outlet watertemperature. Adjustment range: Load, stabilize, unload, Emergency Stop.				
7	<p>Spot check. The operating status of outdoor system can be observed through spot check, and specific display contents are as shown in the following figure:</p>  <ul style="list-style-type: none"> • Display contents of “operating mode”: 1. cooling; 2. heating; 4. pump; 8. Stand-by • Display contents of “number of online units”: the main unit can display the number of online units, and the subordinate unit displays 0. 				
8	<p>Selection code of the compressor</p> <table border="1" data-bbox="311 1724 766 2042"> <tr> <td data-bbox="311 1724 526 1881">  </td> <td data-bbox="526 1724 766 1881">Reserved DIP switch state</td> </tr> <tr> <td data-bbox="311 1881 526 2042">  </td> <td data-bbox="526 1881 766 2042">The diagram denotes selection of constant speed compressor</td> </tr> </table>		Reserved DIP switch state		The diagram denotes selection of constant speed compressor
	Reserved DIP switch state				
	The diagram denotes selection of constant speed compressor				

No.	Detail information	
9	 <p>ADDRESS</p>	<p>When the address is 0, it serves as the main unit.</p>
	 <p>ADDRESS</p>	<p>When the address is 1,2,3.....F, it serves as the subordinate unit 1,2,3.....15.</p>
10	COM (O) 485 communication port (fault code E2)	
11	<p>COM (I) 485 communication port (fault code E2) COM (O) is interconnected with P, Q and E of COM (I), used for RS-485 communication.</p> <ol style="list-style-type: none"> 1) If faults occur between the wired controller and the main unit module, all modules will be shut down. 2) If faults occur between the main unit and subordinate units, the subordinate unit module suffering communication fault will be shut down. Less units will be detected by the wired controller, which may display EA, and in the meanwhile, the indicator lamp of the wired controller will flash. restart 3 minutes later after malfunction be removed. 	
12	<p>high-pressure protection of the system A and discharge temperature switch protection (protection code P0); high-pressure protection of the system B and discharge temperature switch protection (protection code P2); low-pressure protection of the system A (protection code P1); low-pressure protection of the system B (protection code P3); Constant speed compressor: connection of discharge temperature switch and high-pressure switch of the system in series.</p>	
13	Inlet water temperature sensor T62 (TBH2) (fault code EF)	
14	Shell and tube low-temperature ant-freeze sensor T61 (TBH1) (fault code Eb)	
15	<p>Water flow detection (fault code of the main unit E0) is only valid for the main unit but invalid for subordinate units.</p> <ol style="list-style-type: none"> 1) Main unit: if abnormal water flow occurs for the first and second time, the main unit board will display fault code E9. If abnormal water flow occurs the third time, the main unit board will display fault code E0 (off-power recovery is needed), and the wired controller will display fault code E0 (fault is displayed only after 3 detection). 2) Subordinate unit: (water flow detection will not be done). 	
16	Control port (reserved)	
17	Electronic expansion valve of the system B	
18	<p>Electronic expansion valve of the system A Electronic expansion valve is used to control refrigerant flow under different operating modes and different loads.</p>	

No.	Detail information
19	<p>Auxiliary electric heater Attention: the control port value of auxiliary electric heater actually detected is ON/OFF but not 220-230V control power supply, so special attention should be paid when installing the auxiliary electric heater. Attention! Under heating mode, when the main unit board detects total water outlet temperature to be lower than 45°C, the switch will be closed, and the auxiliary electric heater will begin to work; when the total water outlet temperature is higher than 50°C, the switch will be opened, and the auxiliary electric heater will stop working.</p>
20	<p>PUMP. Attention: the control port value of the pump actually detected is ON/OFF but not 220-230V control power supply, so special attention should be paid when installing the pump. 1) After receiving start-up instruction, the pump will be started up instantly, and will maintain start-up state always in the process of operation. 2) In case of refrigerating or heating shutdown, the pump will be shut down 2 minutes after all modules stop operating. 3) In case of shutdown under the pump mode, the pump can be directly shut down.</p>
21	<p>Compressor of the system B; Neutral wire; Four-way valve of the system B; Neutral wire.</p>
22	<p>Numerical code tube. 1) In case of stand-by, the address of the module is displayed; 2) In case of normal operation, 10. is displayed (10 is followed by dot). 3) In case of fault or protection, fault code or protection code is displayed.</p>
23	<p>Compressor of the system A; Neutral wire; Four-way valve of the system A; Neutral wire.</p>
24	<p>Outdoor fan A, controlled by T4.</p>
25	<p>Outdoor fan B, controlled by T4.</p>
26	<p>(reserved port)</p>
27	<p>Input of transformer, 220-230V AC current. (only valid for the main unit)</p>
28	<p>Input of three-phase four-wire power supply (fault code E1) Three phases A, B and C of power supply should exist simultaneously, and the difference of phase angle should be 120° among them. If the conditions are not met, fault of phase sequence or phase lack may occur, and fault code will be displayed. When the power supply returns to normal condition, fault is removed. Attention: phase lacement and phase dislocation of power supply are detected only in the early period after the power supply is connected, and they are not detected while the unit is in operation.</p>
29	<p>Output of transformer</p>



CAUTION

1. Faults

When the main unit suffers faults, the main unit stops operating, and all other units also stop running;
 When the subordinate unit suffers faults, only the unit stops operating, and other units are not affected.

2. Protection

When the main unit is under protection, only the unit stops operating, and other units keep running;
 When the subordinate unit is under protection, only the unit stops operating, and other units are not affected.

6. TRIAL RUN

6.1 Points for attention prior to trial run

6.1.1 After the water system pipeline is flushed several times, please make sure that the purity of water meets the requirements; the system is re-filled with water and drained, and the pump is started up, then make sure that water flow and the pressure at the outlet meet the requirements.

6.1.2 The unit is connected to the main power 12 hours before being started up, to supply power to the heating belt and pre-heat the compressor. Inadequate pre-heating may cause damages to the compressor.

6.1.3 Setting of the wired controller. See details of the manual concerning setting contents of the controller, including such basic settings as refrigerating and heating mode, manual adjustment and automatic adjustment mode and pump mode. Under normal circumstances, the parameters are set around standard operating conditions for trial run, and extreme working conditions should be prevented as much as possible.

6.1.4 Carefully adjust the target flow controller on the water system or the inlet stop valve of the unit, to make the water flow of the system be 90% of the water flow specified in Table 7-1.

6.2 Check item table after installation

Table 6-1

Checking item	Description	Yes	No
Whether installing site is meet for requirements	Units are fixed mounting on level base.		
	Ventilating space for heat exchanger at the air side is meeting for requirement		
	Maintenance space is meeting for requirement.		
	Noise and vibration is meeting for requirement.		
	Sun radiation and rain or snow proof measures are meeting for requirements.		
	External physical is meeting for requirement.		
Whether water system is meeting for requirements	Pipe diameter is meeting for requirement		
	The length of system is meeting for requirement		
	Water discharge is meeting for requirement		
	Water quality control is meeting for requirement		
	Flexible tube's interface is meeting for requirement		
	Pressure control is meeting for requirement		
	Thermal insulation is meeting for requirement		
	Wire capacity is meeting for requirement		
	Switch capacity is meeting for requirement		
	Fuse capacity is meeting for requirement		
	Voltage and frequency are meeting for requirement		
Whether electric wiring system is meeting for requirements	Connecting tightly between wires		
	Operation control device is meeting for requirement		
	Safety device is meeting for requirement		
	Chained control is meeting for requirement		
	Phase sequence of power supply is meeting for requirement		

6.3 Trial run

6.3.1 Start up the controller and check whether the unit displays a fault code. If a fault occurs, remove the fault first, and start the unit according to the operating method in the “unit control instruction”, after determining that there is no fault existing in the unit.

6.3.2 Conduct trial run for 30 min. When the influent and effluent temperature becomes stabilized, adjust the water flow to nominal value, to ensure normal operation of the unit.

6.3.3 After the unit is shut down, it should be put into operation 10 min later, to avoid frequent start-up of the unit. In the end, check whether the unit meets the requirements according to the contents in Table 9.1.

- The target flow controller must be installed correctly. The wires of the target flow controller must be connected according to electric control schematic diagram, or the faults caused by water breaking while the unit is in operation should be the user’s responsibility.
- Do not re-start the unit within 10 min after the unit is shut down during trial run.
- When the unit is used frequently, do not cut off the power supply after the unit is shut down; otherwise the compressor cannot be heated, thus leading to its damages.
- If the unit is not in service for a long time, and the power supply needs to be cut off, the unit should be connected to the power supply 12 hours prior to re-starting of the unit, to pre-heat the compressor.



CAUTION

- The unit can control start-up and shut-down of the unit, so when the water system is flushed, the operation of the pump should not be controlled by the unit.
- Do not start up the unit before draining the water system completely.

7. USE

7.1 Use conditions of the unit

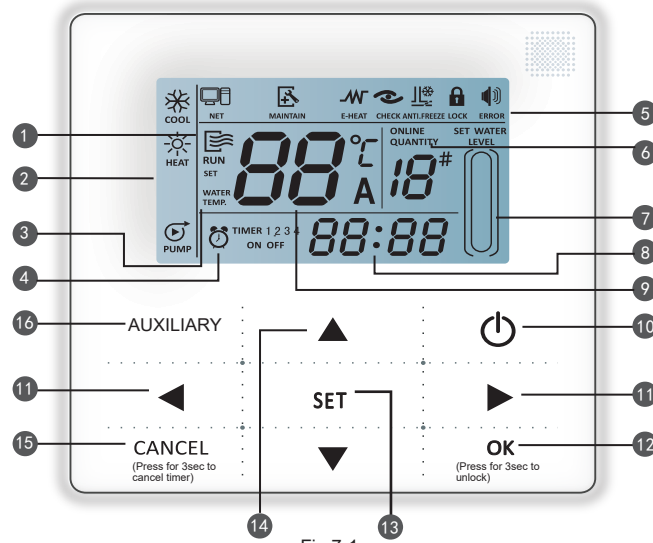

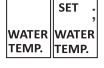



Fig.7-1

- | | |
|---------------------------------|--------------------------|
| 1. Operation icon | 10.ON/OFF Key |
| 2. Mode area | 11.Right, Left Right Key |
| 3. Setting temperature | 12.OK key |
| 4. Timing On/Off | 13. Setting key |
| 5. Function Icon | 14. Add, Reduce key |
| 6. On-line Unit Qty. Indication | 15. Cancel key |
| 7. Reserved | 16. Reserved. key |
| 8. Clock | |
| 9. Water temp. | |

7.2 Operating instructions of buttons

- 1 **Operation icon**  : Indicate the ON and OFF status; when it is ON, it will display; when it is OFF, it will disappear;
- 2 **Mode area**: Indicate the main unit operating mode;
- 3 **Setting temperature: 3 status can be displayed**: 
- 4 **Timing ON/OFF indication**  **TIMER 1 2 3** : Indicate the timing information;
- 5 **Function icon**
 - 1) Computer: Display when connects to computer;
 - 2) Maintenance: When the icon is lighted on it means should arrange professionals to do the cleaning maintenance; long press "AUXILIARY" for 3 seconds then this icon will be off, until the next maintenance;
 - 3) E-heating: Display when the electric auxiliary heating water function is operated;
 - 4) Check: Display when check function is operated;
 - 5) Anti-freezing: Display when the main unit ambient temperature is below 2°C, to remind the main unit should be do the anti-freezing measurement;
 - 6) Lock: When the icon is lighted on, it means the button has been locked (no keys operation for 2 minutes), long press "OK" key for 3 seconds to unlock;
 - 7) Error: When the main unit has error or protection, this icon will be displayed. The unit need to be maintained by professionals.
- 6 **On-line unit qty. indication**: Under normal status display the quantity of the units connected to the wired controller; under check status display the device serial number;
- 7 **Reserved**;
- 8 **Clock**: Under normal status display clock; during timing setting it displays the setting timing time;
- 9 **Water temperature**: Under normal status display water temperature; during water temperature setting it displays the setting numerical value; under the check status display check parameter;

Wired controller the check sequence is as follows:

1	Outlet water temperature Tou->
2	Inlet water temperature Tin->
3	Outdoor ambient temperatures T4->
4	Outdoor pipe temperature T3A->
5	Outdoor pipe temperature T3B->
6	Current of the compressor IA->
7	Current of the compressor IB->
8	Anti-frozen temperature T6->
9	Electronic expansion valv opening FA->
10	Electronic expansion valv opening FB->
11	Last one error or protection ->
12	Last second error or protection->
13	Last third error or protection ->
1	Outlet water temperature Tou.....

- 10 **ON/OFF key**: On and Off functions;
- 11 **Right, Left key**: Under main page to press this key can query the setting water temperature, setting timing etc; during timing setting press the right key then shift to the next step setting; during spot check they are used to turn over the unit parameter information;
- 12 **OK key**: After setting the parameter then press this key to confirm. After keys locking then long press this key for 3 seconds to unlock;
- 13 **Setting key**: Setting the water temperature, timing, mode etc, long press this key for 3 seconds enter to the check;

- 14 **Add, Reduce key**: Setting water temperature, timing, water level etc; during spot check they are used to read over #0~#15 units;
- 15 **Cancel key**: During setting parameters press this key to cancel setting. After timing setting and then long press this key 3 seconds to cancel timing;
- 16 **Reserved key**.

7.3 ON/OFF

Follow the following diagram for system ON/OFF

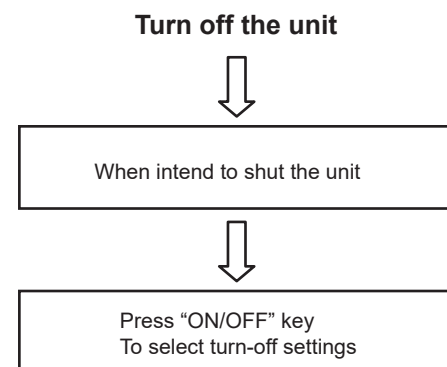
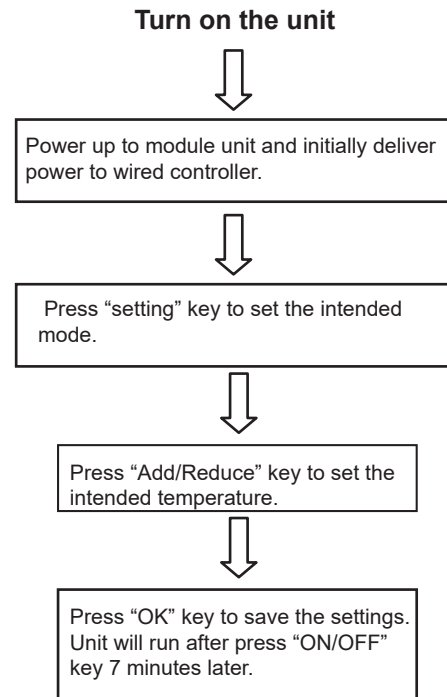

Fig. 7-2

7.4 Control and protection function of unit

8.1.1 The unit has the following protection functions

- 1) Current cut-off protection
- 2) Power supply phase sequence protection
- 3) Protection for over-low suction pressure
- 4) Protection for compressor overcurrent

- 5) Protection for compressor overload
 - 6) Anti-freezing protection
 - 7) Protection for over-high discharge pressure
 - 8) Protection for outlet and inlet water temperature difference
- 8.1.2 The unit also has other control functions:

- 1) Manual test function
- 2) Plug and play system
- 3) RS-485/TS232 Standard serial communication port.

7.5 Troubleshooting

Table 7-1

Error	Possible reason	Detect and settle measure
Over high air discharge pressure (Cooling operation)	Air or other non-condensing gas still in the system	Discharge gas from fluorin charging inlet. Re-vacuum the system if necessary.
	Fins in the condenser are dirty or foreign substance blocking fins.	Clean condenser fins.
	Insufficient chilling air volume or condenser fan error	Check and repair the condenser fan, recover the normal operation
	Excessive high air suction pressure	See "Excessive high air suction pressure"
	Excessive refrigerant charging volume	Discharge the excessive refrigerant
	Over high ambient temperature	Check ambient temperature
Over low air discharge pressure (Cooling operation)	Over cool air in the side of air heat exchanger	Check ambient temperature
	Refrigerant leakage or insufficient refrigerant volume	Test leakage or charge sufficient refrigerant to the system
	Excessive low air suction pressure	See "Excessive low air suction pressure"
Over high air suction pressure (Cooling operation)	Excessive refrigerant charging volume	Discharge the excessive refrigerant
	Over high temperature in chilling water inlet	Check thermal insulation layer of water pipe and the specification of this layer
Over low air suction pressure (Cooling operation)	Insufficient water flow volume	Check temperature difference at water inlet and outlet, and adjust the water flow volume
	Over low temperature in chilling water inlet and outlet	Check and installation state
	Refrigerant leakage or insufficient refrigerant volume	Test leakage or charge sufficient refrigerant to the system
	Incrustant in evaporator	Eliminate incrustant
Over high air discharge pressure (Heating operation)	Insufficient water flow	Check temperature difference at water inlet and outlet, and adjust the water flow volume
	Air or other non-condensing gas still in the system	Discharge gas from fluorin charging inlet. Re-vacuum the system if necessary.
	Incrustant in water side of heat exchanger	Eliminate incrustant
	Over high temperature in chilling water inlet	Check water temperature
	Excessive high air suction pressure	See "Excessive high air suction pressure"
Over low air discharge pressure (Heating operation)	Over low temperature of chilling water	Check chilling water temperature
	Refrigerant leakage or insufficient refrigerant volume	Test leakage or charge sufficient refrigerant to the system
	Excessive low air suction pressure	See "Excessive low air suction pressure"
Over high air suction pressure (Heating operation)	Over heat air in the side of air heat exchanger	Check ambient temperature around it
	Excessive refrigerant charging volume	Discharge the excessive refrigerant
Over low air suction pressure (Heating operation)	Insufficient refrigerant charging volume	Charge sufficient refrigerant to the system
	Insufficient air flow volume	Check fan rotating direction
	Air loop short-circuit	Reason about remove air short-circuit
	Insufficient frost-removal operation	Error comes out from 4-way valve or thermal resistor. Replace a new one if necessary.
Compressor stops because of freeze-proof protection (Cooling operation)	Insufficient chilling water flow volume	Error comes from pump or flow-type water volume control. Check and repair or replace a new one.
	Gas still in water loop	Discharge air
	Thermal resistor error	Upon error have been confirmed, please replace a new one.
Compressor stops because of Hi-pressure protection	Over high air expelling pressure	See "Over high air expelling pressure"
	Hi-pressure switch error	Upon error have been confirmed, please replace a new one.

Table 7-1

Error	Possible reason	Detect and settle measure
Compressor stops because of motor Overcurrent.	Over high air expelling pressure and air suction pressure	See "Over high air expelling pressure" and "Over high air suction pressure"
	Hi-voltage or Lo-voltage, signal phase or phase unbalance	Confirm voltage not higher or lower than the rated voltage 20V
	Short circuit comes out from motor or connecting interface	Confirm resistors at motor are connected corresponding to terminals
	Overcurrent assembly error	Replace a new one
Compressor stops because of integrate temperature sensor or air discharge temperature protection.	Over high or over low voltage	Confirm voltage not higher or lower than the rated voltage 20V
	Over high air expelling pressure or excessive low air suction pressure	See "Over high air expelling pressure" and "excessive low air suction pressure "
	Component error	Check the integrated temperature sensor after motor is cool down.
Compressor stops because of Lo.-pressure protection	Filter in front (or rear) of expanding valve is blocked	Replace a new filter
	Lo-voltage switch error	If the switch is defective, please replace a new one.
	Excessive low air suction pressure	See "Excessive low air suction pressure"
Abnormal noise gives out form compressor	Liquid refrigerant flows into compressor from evaporator result in liquid slugging.	Adjust refrigerant charge volume
	Aging of compressor	Replace a new compressor
Compressor is unable to drive	Overcurrent relay trip up, fuse burnt out	Replace damaged assembly
	Control circuit without power though	Check the wiring of control system
	Hi-voltage or lo-voltage protection	Reference to mention in above the parts of air suction and discharge pressure error
	Coils in contactor are burnt out	Replace damaged assembly
	Wrong connection of phase sequence	Re-connect and adjust the any 2 wires among 3 phases
	Water system error and flow type volume controller short connection	Check water system
Air side heat exchanger excessive frost	Error signal delivered from wire controller	Find out the error type and carry out the corresponding measure to settle
	4-way valve or thermal resistor error	Check the running state. Replace a new one if necessary.
With noise	Air loop short-circuit	Settle the short-circuit of air discharge
	Fixing screws at panel are loosen	Fix up all assemblies

8. MAINTENANCE AND UPKEEP

8.1 Failure of wired controller and its reason



8.1.1 Failure information and code

In case the unit runs under abnormal condition, failure protection code will display on both control panel and wired controller, and the indicator on the wired controller will flash with 5Hz. The display codes are shown in the following table:

Table 8-1

No.	Code	Reason
1	E0	Water flow detection error (The third time)
2	E1	Power phase sequence error
3	E2	Communication error
4	E3	Total water outlet temperature sensor error
5	E4	Outlet water temperature sensor in heat exchanger error
6	E5	Pipe temperature sensor in condenser A error
7	E6	Pipe temperature sensor in condenser B error
8	E7	Outdoor ambient temperature sensor error or power supply protection
9	E8	(Reserved failure code)
10	E9	Water flow detection error (The first and second times)
11	EA	Main unit detect that auxiliary unit's quantity have decreased.
12	Eb	Freeze-proof temperature sensor 1 in shell and tube exchanger error
13	EC	Wire control did not found out any on-line module unit.
14	Ed	1-hour consecutive 4-times PE protection
15	EF	Inlet water temperature sensor error
16	P0	High pressure or air discharge temperature protection error in system A
17	P1	Low pressure protection System A
18	P2	High pressure or air discharge temperature protection in system B
19	P3	Low pressure protection System B
20	P4	Current protection in system A
21	P5	Current protection in system B
22	p6	Condenser high pressure protection in system A
23	p7	Condenser high pressure protection in system B
24	p8	System A is air discharge temperature sensor in digital compressor
25	P9	Protection of outlet and inlet water temperature difference
26	PA	Low ambient temperature drive-up protection
27	Pb	System freeze-proof protection
28	PC	(Reserved failure code)
29	PE	Low-temperature protection of shell-and-tube heat exchanger
30	F1	Wire controller failure
31	F2	(Reserved failure code)

8.1.2 Ordinary displayed data

- Ordinary displayed data are displayed in all display pages.
- If the unit system is under running state, i.e. one or more than one scroll unit is under running operation, there will be a dynamic display of . If the system is under OFF state, there is no display.
- If the communication with the main unit scroll unit is normal, it displays E2. There will be no display under the failure state of main unit communication connection.
- If it is under the host computer network control,  displays, otherwise there is no display.
- If it is under wired controller locked or button locked state, it displays  the lock mark. There will be no display after the lock is unlocked.

8.1.3 Treatment of display data

The data display area is divided into Up area and Down area, with two groups of two-digit half 7-segment digital display, respectively.

- Temperature display**
Temperature display is used for displaying the total outlet water temperature of unit system, outlet water temperature of heat exchanger, condenser pipe temperature T3A of system A, condenser pipe temperature T3B of system B, outdoor environmental temperature T4, and setting temperature Ts, with allowable data display scope $-15^{\circ}\text{C}\sim 70^{\circ}\text{C}$. If the temperature is higher than 70°C , it is displayed as 70°C . If there is no effective date, it displays "—" and indication point $^{\circ}\text{C}$ is on.
- Current display**
Current display is used for displaying scroll unit system A compressor current IA or system B compressor current IB, with allowable display scope 0A~99A. If it is higher than 99A, it is displayed as 99A. If there is no effective date, it displays "—" and indication point A is on.
- Failure display**
It is used for displaying the total failure warning date of unit or that of scroll unit, with failure display scope E0~EF, E indicating failure, 0~F indicating failure code. "E-" is displayed when there is no failure and indication point $\#$ is on at the same time.
- Protection display**
It is used for displaying the total system protection data of unit or the system protection data of scroll unit, with protection display scope P0~PF, P indicating system protection, 0~F indicating protection code. "P-" is displayed when there is no failure and indication point $\#$ is on at the same time.
- Unit number display**
It is used for displaying the address number of the currently selected scroll unit, with display scope 0~15 and indication point $\#$ is on at the same time.

f. Display of online unit number and startup unit number

They are used for displaying the total online scroll units of the whole unit system and the number of the scroll unit under running state, respectively, with display scope 0~16.

Any time when the spot check page is entered to display or change scroll unit, it is needed to wait for the up-to-date data of the scroll unit received and selected by wired controller. Before receiving the data, the wired controller only displays "—" on the data display Up area, and the down area displays the address number of the scroll unit. No page can be turned, which continues until the wired controller receives the communication data of this scroll unit.

8.1.4 Main page display

Main page display consists of several pages and the total number of pages is not fixed.

- The default display is the first page; other pages are displayed by pressing page-up/down button circularly.
- The first page of data display Up area displays the total outlet water temperature, and then the total outlet water temperature and the heat exchanger outlet water temperature are displayed according to the page number circularly and in turn.
- The first page of data display Down area displays the number of online units, and the second page displays the number of startup running units
- The first page of data display Down area shows the total load rate of compressor and the fourth page displays the address corresponding to unit number.
- When all the pages of the main page data are displayed, continue to press page-down button to display the first page, and press page-up from the first page to display the last page.

8.1.5 Query display

Press the "▲" or "▼" key of wire controller to adjust the main unit serial number can query 16 sets main units' status information from #0~#15. Press " " or " " to adjust the spot check sequence number of one main unit then can query all the status information of this unit.

Spot check content according to the main unit model wired controller

1	Outlet water temperature Tou->	8	Anti-frozen temperature T6->
2	Inlet water temperature Tin->	9	Electronic expansion valv opening FA->
3	Outdoor ambient temperatures T4->	10	Electronic expansion valv opening FB->
4	Outdoor pipe temperatureT3A->	11	Last one error or protection ->
5	Outdoor pipe temperatureT3B->	12	Last second error or protection->
6	Current of the compressor IA->	13	Last third error or protection ->
7	Current of the compressor IB->	1	Outlet water temperature Tou.....

8.1.6 Care and maintenance

Maintenance of main parts

- Close attention should be paid to the discharge and suction pressure during the running process. Find out reasons and eliminate the failure if abnormality is found.
- Control and protect the equipment. See to it that no random adjustment be made on the set points on site.
- Regularly check whether the electric connection is loose, and whether there is bad contact at the contact point caused by oxidation and debris etc., and take timely measures if necessary. Frequently check the work voltage, current and phase balance.
- Check the reliability of the electric elements in time. Ineffective and unreliable elements should be replaced in time.

8.1.7 Water quality inspection and dirt remove

- According to the local water quality, please inspect the water regularly. We recommended you to respect it a half year a time and change the circulate water two years a time.
- After long-time operation, calcium oxide or other minerals will be settled in the heat transfer surface of the water-side heat exchanger. These substances will affect the heat transfer performance when there is too much scale in the heat transfer surface and sequentially cause that electricity consumption increases and the discharge pressure is too high (or suction pressure too low). Organic acids such as formic acid, citric acid and acetic acid may be used to clean the scale. But in no way should cleaning agent containing fluoroacetic acid or fluoride should be used as the water-side heat exchange is made from stainless steel and is easy to be eroded to cause refrigerant leakage. Pay attention to the following aspects during the cleaning and scale-removing process:
 - Water-side heat exchanger should be done by professionals. Please contact the local air-conditioner customer service center.
 - Clean the pipe and heat exchanger with clean water after cleaning agent is used. Conduct water treatment to prevent water system from being eroded or re-absorption of scale.
 - In case of using cleaning agent, adjust the density of the agent, cleaning time and temperature according to the scale settlement condition.
 - After pickling is completed, neutralization treatment needs to be done on the waste liquid. Contact relevant company for treating the treated waste liquid.
 - Protection equipments (such as goggles, gloves, mask and shoes) must be used during the cleaning process to avoid breathing in or contacting the agent as the cleaning agent and neutralization agent is corrosive to eyes, skins and nasal mucosa.

8.1.8 Winter shutdown

For shutdown in winter, the surface of the unit outside and inside should be cleaned and dried. Cover the unit to prevent dust. Open discharge water valve to discharge the stored water in the clean water system to prevent freezing accident (it is preferable to inject antifreezer in the pipe).

8.1.9 Replacing parts

Parts to be replaced should be the ones provided by our company. Never replace any part with different part.

8.1.10 First startup after shutdown

The following preparations should be made for re-startup of unit after long-time shutdown:

- Thoroughly check and clean the unit.
- Clean water pipe system.
- Check pump, control valve and other equipments of water pipe system.
- Fix connections of all wires.
- It is a must to electrify the machine before startup.

8.1.11 Refrigeration system

Determine whether refrigerant is needed by checking the value of suction and discharge pressure and check whether there is a leakage. Air tight test must be made if there is a leakage or parts of refrigerating system is to be replaced. Take different measures in the following two different conditions from refrigerant injection.

1) Total leakage of refrigerant. In case of such situation, leakage detection must be made on the pressurized nitrogen used for the system. If repair welding is needed, welding cannot be made until all the gas in the system is discharged. Before injecting refrigerant, the whole refrigeration system must be completely dry and of vacuum pumping.

- Connect vacuum pumping pipe at the fluoride nozzle at low-pressure side.
 - Remove air from the system pipe with vacuum pump. The vacuum pumping lasts for above 3 hours. Confirm that the indication pressure in dial gauge is within the specified scope.
 - When the degree of vacuum is reached, inject refrigerant into the refrigeration system with refrigerant bottle. Appropriate amount of refrigerant for injection has been indicated on the nameplate and the table of main technical parameters. Refrigerant must be injected from the low pressure side of system.
 - The injection amount of refrigerant will be affected by the ambient temperature. If the required amount has not been reached but no more injection can be done, make the chilled water circulate and start up the unit for injection. Make the low pressure switch temporarily short circuit if necessary.
- 2) Refrigerant supplement. Connect refrigerant injection bottle on the fluoride nozzle at low-pressure side and connect pressure gauge at low pressure side.
- Make chilled water circulate and start up unit, and make the low pressure control switch short circuit if necessary.
 - Slowly inject refrigerant into the system and check suction and discharge pressure.



CAUTION

- Connection must be renewed after injection is completed.
- Never inject oxygen, acetylene or other flammable or poisonous gas to the refrigeration system at leakage detection and air tight test. Only pressurized nitrogen or refrigerant can be used.

8.1.12 Disassembling compressor

Follow the following procedures if compressor needs to be disassembled:

- 1) Cut off the power supply of unit.
- 2) Remove power source connection wire of compressor.
- 3) Remove suction and discharge pipes of compressor.
- 4) Remove fastening screw of compressor.
- 5) Move the compressor.

8.1.13 Auxiliary electric heater

When the ambient temperature is lower than 2°C, the heating efficiency decreases with the decline of the outdoor temperature. In order to make the air-cooled heat pump stably run in a relatively cold region and supplement some heat lost due to de-frosting. When the lowest ambient temperature in the user's region in winter is within 0°C~10°C, the user may consider to use auxiliary electric heater. Please refer to relevant professionals for the power of auxiliary electric heater.

8.1.14 System antifreezing

In case of freezing at the water-side heat exchanger interval channel, severe damage may be caused, i.e. heat exchange may be broken and appears leakage. This damage of frost crack is not within the warranty scope, so attention must be paid to antifreezing.

- 1) If the unit that is shutdown for standby is placed in an environment where the outdoor temperature is lower than 2°C, the water in the water system should be drained.
- 2) Water pipe may be frozen when the chilled water target flow controller and anti-freezing temperature sensor become ineffective at running, therefore, the target flow controller must be connected in accordance with the connection diagram.
- 3) Frost crack may happen to water-side heat exchanger at maintenance when refrigerant is injected to the unit or is discharged for repair. Pipe freezing is likely to happen any time when the pressure of refrigerant is below 0.4Mpa. Therefore, the water in the heat exchanger must be kept flowing or be thoroughly discharged.

8.1.15 Wiring of "ON/OFF" weak electric port

First, corresponding parallel connect the "ON/OFF" port of each module's electric control box (not more than 16), then, connect the "ON/OFF" signal (from the user's timer) to the "ON/OFF" port of main unit as follows.

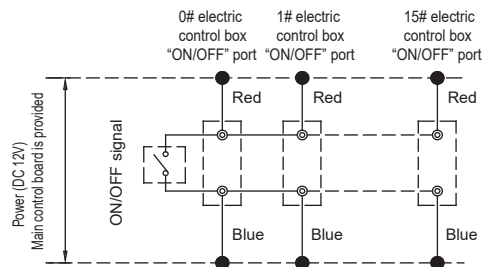

RECORD TABLE OF TEST RUN AND MAINTENANCE

Table 8-2

Model:	Code labeled on the unit:
Customer name and address:	Date:
<p>1. Whether there is sufficient water flow passing waterside heat exchanger? ()</p> <p>2. Whether leakage detection has been made on all the water pipe? ()</p> <p>3. Whether pump, fan and motor are lubricated? ()</p> <p>4. Whether unit has been through 30-minute operation? ()</p> <p>5. Check temperature of chilled water or hot water</p> <p style="padding-left: 40px;">Inlet () Outlet ()</p> <p>6. check air temperature of air-side heat exchanger:</p> <p style="padding-left: 40px;">Inlet () Outlet ()</p> <p>7. Check refrigerant suction temperature and superheating temperature:</p> <p style="padding-left: 40px;">Refrigerant suction temperature: ()()()()()</p> <p style="padding-left: 40px;">Superheating temperature: ()()()()()</p> <p>8. Check pressure:</p> <p style="padding-left: 40px;">Discharge pressure: ()()()()()</p> <p style="padding-left: 40px;">Suction pressure: ()()()()()</p> <p>9. Check running current: ()()()()()</p> <p>10. Whether unit has been through refrigerant leakage test? ()</p> <p>11. Whether unit inside and outside is cleared? ()</p> <p>12. Whether there is noise on all the panels of unit? ()</p> <p>13. Check whether the main power source connection is correct. ()</p>	

RECORD TABLE OF ROUTINE RUNNING

Table 8-3

Model:											
Date:											
Weather:											
Operation time: Startup ()						Shutdown ()					
Outdoor temperature	Dry bulb	°C									
	Wet bulb	°C									
Indoor temperature		°C									
Compressor	High pressure	MPa									
	Low pressure	MPa									
	Voltage	V									
	Current	A									
Air temperature of air-side heat exchanger	Inlet (dry bulb)	°C									
	Outlet (dry bulb)	°C									
Temperature of chilled water or hot water	Inlet	°C									
	Outlet	°C									
Current of cooling water pump or hot water pump		A									
Note:											

9. APPLICABLE MODELS AND MAIN PARAMETERS

Table 9-1

Model		MGBT-F60W/RN1
Cooling capacity	kW	60
Heating capacity	kW	64
Standard cooling input	kW	19.3
Cooling rated current	A	33.6
Standard heating input	kW	19.8
Heating rated current	A	34.3
Power supply		380-415V 3N 50Hz
Operation control		Control of wired controller, manual/auto startup, running state display, failure alert etc.
Safety device		High or low pressure switch, freeze-proof device, water flow volume controller, Overcurrent device, power phase sequence device etc.
Refrigerant	Type	R410A
	Charging volume kg	6.0×2
Water pipe system	Waterflow volume m ³ /h	10.3
	Hydraulic resistance lose kPa	15
	Water side heat exchanger	Shell & tube type heat exchanger
	Max. pressure MPa	1.0
	Inlet and outlet pipe dia.	100mm(Inside nominal diameter)
Air side heat exchanger	Type	Fin coil model
	Air flow volume m ³ /h	24 000
Outline dimension	L mm	2000
	W mm	900
	H mm	1880
N.W. of the unit	kg	580
Operation Weight	kg	650
Packing dimension	L×W×H mm	2090×985×2095
<p>Notes: the above data is measured base on the following working condition. Refrigeration mode under nominal working condition: water flow 0.172m³/(h•kW), outlet water temperature of chilled water 7℃, air inlet temperature of condenser 35℃. Heating mode under nominal working condition: water flow 0.172m³/(h•kW), outlet water temperature of hot water 45℃, air inlet temperature of condenser DB/WB 7/6℃.</p>		

版本更换明细（本页不出菲林，仅作为电子文档说明）

印刷技术要求

材质	80g双胶纸
规格	210*297mm(双面)
颜色	黑白
其他	/

设计更改记录表（仅做说明用，不做菲林）

版本升级	更改人	更改日期	更改主要内容	涉及更改页面 (印刷页码)
E-F			更改线控器描述	
F-G			增加“ACCESSORIES”部分并调整“MAIN PARTS OF THE UNIT”部分的表格以及图片位置	
G-H			按照要求转成pdf格式并做分页处理 封底旧编码改为新编码，增加版本号， 删除图号最后一页增加材质要求 第十六页单词“ADDRRSS”更正为 “ADDRESS”页码进行居中处理并删除 “I&O MANUAL”字样	
H-I	张丙	20240122	增加水系统按照要求 警告更改缓冲水箱、 膨胀阀罐、电加热、 水系统图、水质、 水路管径及防风雪内容。	整本